

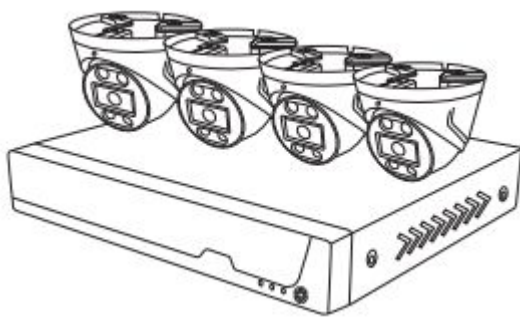

# ***User Manual***

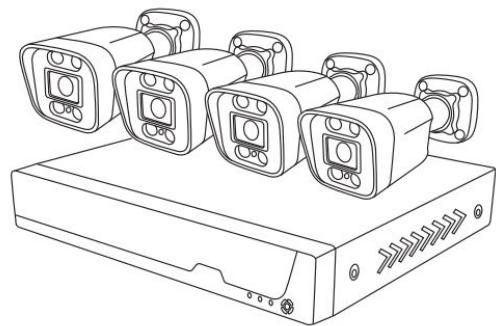

**Model: FN9108E-T4/FNA108E-T4**



**Model: FN9108E-B4/FNA108E-B4**



**Model: FN9108H/ FN9108HE/FNA108H/FNA108HE**

# Table of Contents

---

Table of Contents.....	I
Security Warning.....	IV
Important Safety Instructions.....	V
Preface.....	VI
1 Overview.....	1
1.1 Product Introduction.....	1
1.2 Key Features.....	1
1.3 Relevant Version.....	3
1.4 Hard Disk Installation.....	3
1.5 NVR Rear Panel.....	4
2 GUI.....	6
2.1 Before Starting.....	6
2.1.1 Icons Description.....	6
2.1.2 Common Operations.....	6
2.1.3 USB Mouse Operation.....	7
2.2 Login.....	8
2.3 Guide.....	9
2.4 Shortcut Menu.....	11
2.4.1 Channel Config.....	11
2.4.2 Main Menu.....	12
2.4.3 Playback.....	12
2.4.4 Record.....	15
2.4.5 Backup.....	17
2.4.6 PTZ Control.....	18
2.4.7 IPC Config.....	18
2.4.8 Info.....	22
2.4.9 Shutdown.....	23

2.5 Main Menu.....	23
2.5.1 Configuration.....	24
2.5.2 Preview.....	25
2.5.3 Record.....	26
2.5.4 Backup.....	27
2.5.5 Network.....	28
2.5.6 HDD.....	30
2.5.7 User.....	31
2.5.8 Event.....	32
2.5.9 Restore.....	34
2.5.10 Upgrade.....	34
2.5.11 IPC Config.....	35
2.5.12 Channel Config.....	35
3 Access the NVR in Foscam App.....	36
3.1 Download the Foscam APP.....	36
3.2 Create A Foscam Account.....	36
3.3 Add Device in Foscam App.....	37
3.4 Foscam APP Surveillance Window.....	38
3.5 Watch Live.....	38
3.6 Setting.....	40
3.6.1 NVR Info.....	40
3.6.2 NVR Firmware.....	41
3.6.3 Camera Firmware.....	41
3.6.4 Recording Playback.....	41
3.6.5 Hard disk information.....	41
3.6.6 Reboot NVR.....	42
3.6.7 Delete NVR.....	42
4 Surveillance Software Foscam VMS.....	43
4.1 Software Installation.....	43
4.2 Create A Local Account.....	44

4.3 Add Device.....	45
4.3.1 LAN Add.....	46
4.3.2 Manual add.....	47
4.4 Surveillance Software GUI.....	50
4.5 Setup.....	54
4.5.1 Basic.....	54
4.5.2 Device Manager.....	60
4.5.3 Application.....	62
4.5.4 System.....	70
5 Appendix.....	73
5.1 HDD Capacity Calculation.....	73
5.2 Specifications.....	74
5.3 FAQ.....	93
5.4 Glossary.....	94
5.5 CE & FCC.....	95
5.6 WARRANTY.....	95
5.7 Statement.....	99
5.8 Obtaining Technical Support.....	100

## Security Warning

- Please change the password of your Foscam App account, and NVR and cameras user name regularly. The password should contain a combination of numbers, letters and special characters.
- Please keep the user name and password of your cameras, NVR and Foscam App account safe.
- Please update your device to the latest firmware regularly for an optimal user experience.

## Important Safety Instructions

---

This chapter describes how to use the product properly so as to prevent danger and property loss. Be sure to follow the security instructions when operating this product.

The CR1220 model lithium battery is used inside the device. If other types of batteries are used, there is a danger of explosion. When replacing the battery, do not put the old battery into fire or handle it with household garbage. Please dispose of used batteries in accordance with local laws and regulations

# Preface

---

Welcome to use our product, Network Video Recorder (NVR). This document mainly focuses on the installation and configuration of NVR application system. With high performance video, user-friendly GUI, and practical industrial designs. This series NVR is suitable for civil applications such as homes, stores, internet cafes, and small businesses in addition to mainstream security and surveillance applications.

## Declaration

- The feature of product on this manual is just for reference. Please prevail in physical product.
- The manual provides multiple product models for reference. The specific operations are not listed one by one. Please follow the operations depending on the actual product.
- Because the actual environment may be discrepant, the actual values of some data may be different from the values provided in the manual. If there are any question or dispute, the final interpretation of prevails.
- If you do not follow the manual during operation, you will bear any loss caused thereof.

## Installation Environment

### Precautions

- Please keep the device horizontally and avoid inclination or inversion.
- Do not install the wireless NVR in humid and dusty environment.
- Put the wireless NVR in drafty environment in case of ventilation port being blocked.
- Don't touch the power switch with wet hand or damp items to avoid shock.
- Do not splash liquid or metal filing on the NVR To avoid short-circuit fault or blaze.
- Explosion may happen because of improper replacement of battery, do not replace it by yourself; If you need, make sure it is the same type of battery. And do not open or repair it.
- Do not take the device apart when it is operating (or connecting to power).
- Please use suitable and professional hard disk to ensure continues and stable recording.

- Lightning protection is needed when device is connected to communication cables. Ethernet cable which comes from outside, connecting to the wireless NVR directly is forbidden.
- Check the power supply to avoid damage because of voltage mismatch.
- Make sure the wireless NVR working within suitable temperature and humidity environment.

Short circuit may occur when dust become wet on circuit board. Please clean the dust on circuit board, connectors, and NVR case.



# 1 Overview

---

## 1.1 Product Introduction

This document introduces a series of NVR products, including: FN9108E-B4 Kit, FN9108E-T4 Kit, FNA108E-B4 Kit, FNA108E-T4 Kit, FN9108H, FN9108HE, FNA108H, FNA108HE. This advanced product series receives a high quality video stream that is transmitted digitally by the IP Camera (IPC). The product can perform live video preview, recording, playback, remote access, and backup simultaneously.

## 1.2 Key Features

### Network Monitoring

You can access the NVR system remotely through the Video Management System (VMS) and Foscam APP, or access the NVR system locally by using the display or monitor.

### Multi-screen Preview

Multi-screen preview indicates that several pages are displayed on the screen of the monitor based on the same scale.

### Recording

The NVR supports recording and storing video files on a Hard Disk Drive (HDD). Stored videos files can be queried or played back through local GUI.

Recording can be classified into schedule recording, and alarm recording from low priority to high priority. If recording of any two types is enabled at the same time, only the recording of a higher priority takes effect.

- Schedule recording  
You can select the scheduled time segment to enable or disable recording.
- Motion detect recording  
After the motion detect is enabled and recording is selected, motion detect recording is enabled when motion detection is triggered in the detection time segment and detection area.
- Alarm recording

After the Shelter is enabled and recording is selected, If the video is occluded, the video channel will have an alarm flag alert that triggers an alarm and alarm logging will be enabled.



### Note

When NVR system time and IPC time are different, the NVR recording will based on the NVR system time.

## Playback

You can play recording video files stored in the Hard disk. Recording includes schedule recording, manual recording, motion recording and alarm recording. Single-screen playback, four screens or nine screens synchronous playback are supported.

## Alarm

Motion Detection Alarm, Human Detection Alarm and Vehicle Detection Alarm.(Human Detection Alarm and Vehicle Detection Alarm only supports FN9108E-B4 kit/ FN9108E-T4 kit)

You can configure detection information about the corresponding channel in the NVR system. When an object moves in the detection time segment and detection area, an alarm is triggered, the NVR system enables detection recording, sends pictures to your mailbox.

## Manage

You can search for IPC devices in the LAN through the NVR and add IPC devices to the NVR channel. Through the NVR, you can also manage IPC devices.

## HDD Management

When the HDD becomes exceptional (for example, HDD Loss, HDD Full, and HDD Error), the NVR buzzer sounds an alarm.

When the HDD is full, you can select the cycle cover the earliest recording or stop recording.



### Note

Only FN9108E-B4-2T kit / FN9108E-T4-2T has a 2T hard drive installed at the factory.

## Other Functions

- Support the logging function.
- Support local GUI output and perform shortcut operations through the mouse (left click to select, right click to return to the previous menu).

- Three roles can access the NVR, which are respectively visitor, operator, and administrator. The rights of the three roles vary from low to high.

## 1.3 Relevant Version

Name	Recommended Configuration
Monitor	The maximum resolution of NVR support displays is 4K(3840x2160).
Network	10/100M Ethernet or above.
POE Standard	IEEE 802.3at/af

## 1.4 Hard Disk Installation

If your NVR is FN9108H, FN9108HE or FN9108E-B4-N, you must install the hard disk to the NVR. FN9108E-B4-2T kit has a 2T hard drive installed at the factory.

### WARNING

- Before installing a hard disk drive (HDD), please make sure the power is disconnected from the NVR.
- It is recommended that a hard drive be used in 7200 high-speed or above.

**Step 1:** Remove the cover from the NVR by unfastening the screws on the rear and bottom.



**Step 2:** Connect one end of the data cable and power cable to the motherboard of NVR and the other end to the HDD.

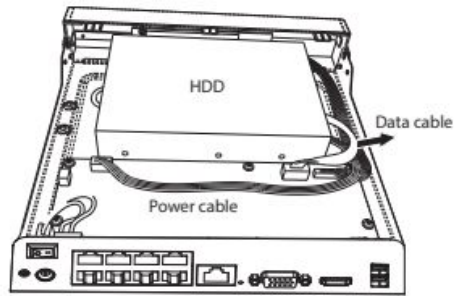

**Step 3:** Place the HDD on the bottom of the device and then fasten the screws on the bottom to fix the HDD.

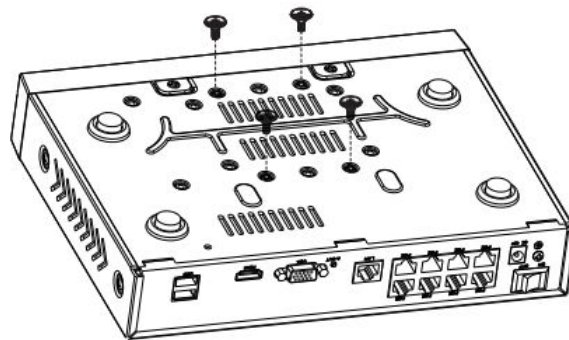

**Step 4:** Re-install the cover of the NVR and fasten screws.

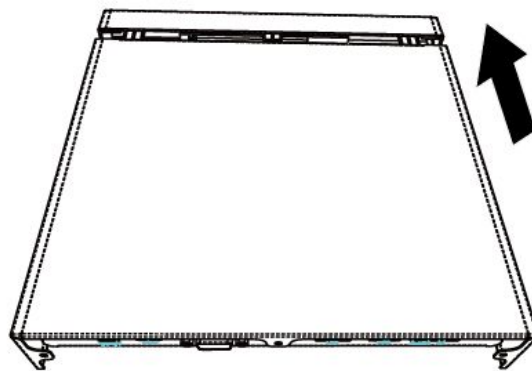

## 1.5 NVR Rear Panel

FN9108HE/FNA108HE/FN9108E/FNA108E:

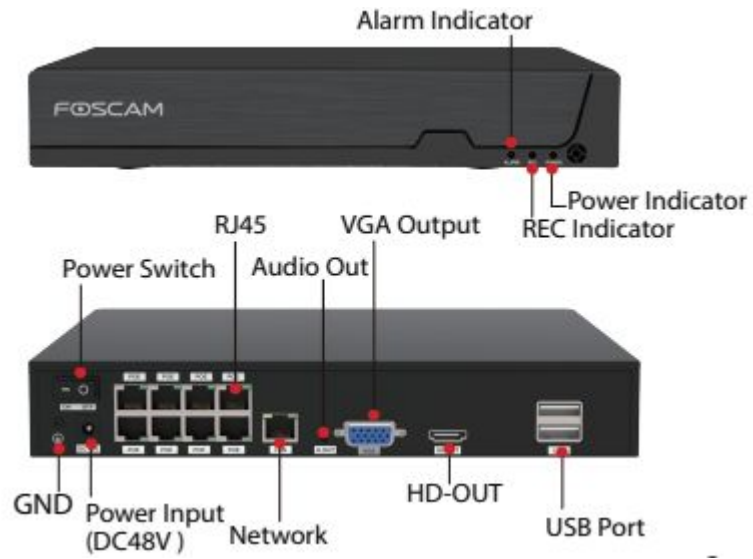

FN9108H/FNA108H:

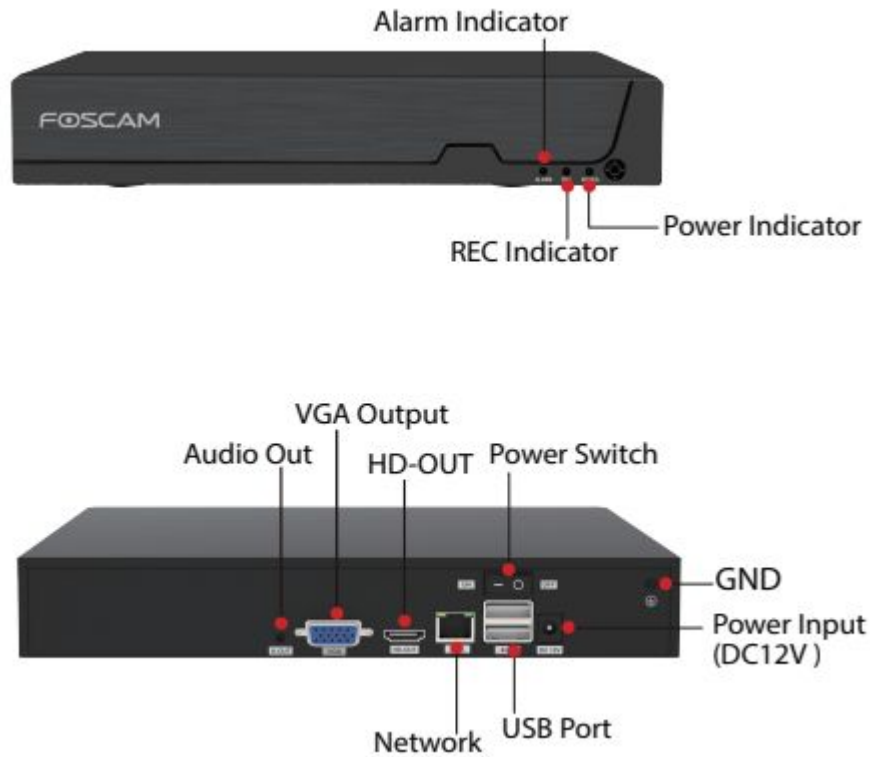

# 2 GUI

---

Please refer to the **Quick Setup Guide** if you install the NVR for the first time. You can visit the local NVR device via the display or monitor, and view or manage NVR system.

## 2.1 Before Starting

You need to know some basic information before you log on to the NVR system with the monitor or display.

### 2.1.1 Icons Description

- In the live view mode, there are icons at the left top of the full screen.



: The HDD is full, and the recording has been stopped. A HDD is not inserted into the NVR or the HDD connected to the NVR is abnormal.

- In the live view mode, there are icons at the right bottom of the screen for each channel,



: Human Detection Alarm. Identify whether someone is moving within the range of the camera. Only FN9108E-B4 kit / FN9108E-T4 kit supports this function.



: Vehicle Detection Alarm. Identify whether vehicle is moving within the range of the camera. Only FN9108E-B4 kit / FN9108E-T4 kit supports this function.



: Motion Detection Alarm. The motion is detected during the detection time in the detection area, the NVR will alarm.



: NVR is recording for the IPC.



: You can click this icon to control whether IPC records sound.

### 2.1.2 Common Operations

#### Starting Up the NVR

Turn on the power, The Power indicator LED should turn green indicating that the device begins to start up.



**Note**

If the power LED indicator on the front panel is off, please check if the power supply is plugged into an electrical outlet.

## Shutting Down the NVR

Proper ways to shut down the NVR in the GUI interface: After login, right-click the mouse, you can click **Shutdown** in the shortcut menu. Choose **Shutdown**, click the **OK** button in the confirmation box. Then turn off the power switch on the rear panel, the power LED indicator on the front panel turns off.



**Note**

Don't turn off the power directly when you turning on.

## Reset

You can reset the NVR device to restore the factory settings. You can choose any one of the following methods operate.

- Reset button: Press and hold it for 3 seconds to reset all parameters to factory defaults on the bottom of the NVR.
- Local GUI: Right-click the mouse, Choose **Main Menu > Restore** in the Menu interface, then choose to restore defaults in the **Restore factory settings** interface.

### 2.1.3 USB Mouse Operation

Plug USB mouse into one of the USB interfaces on the rear panel of the NVR.

The operation of the mouse on the local GUI is shown as below.

Name	Action	Description
Left-Click	Single-Click	Menu or window: select and enter.
	Double-Click	Preview mode or Playback mode: Switch between single-screen and multi-screen.
	Click and Drag	Time or Area box: Select the time or zone range. Time bar: Drag time bar.

		Live view: Moving channel arrangement order.
Right-Click	Single-Click	Live view: Show menu. Menu: Exit current menu to upper level menu.



**Note**

The Single-Click mentioned in this article is refer to the left mouse click.

## 2.2 Login

For your security, please set a new user name and password for your NVR before Log In.

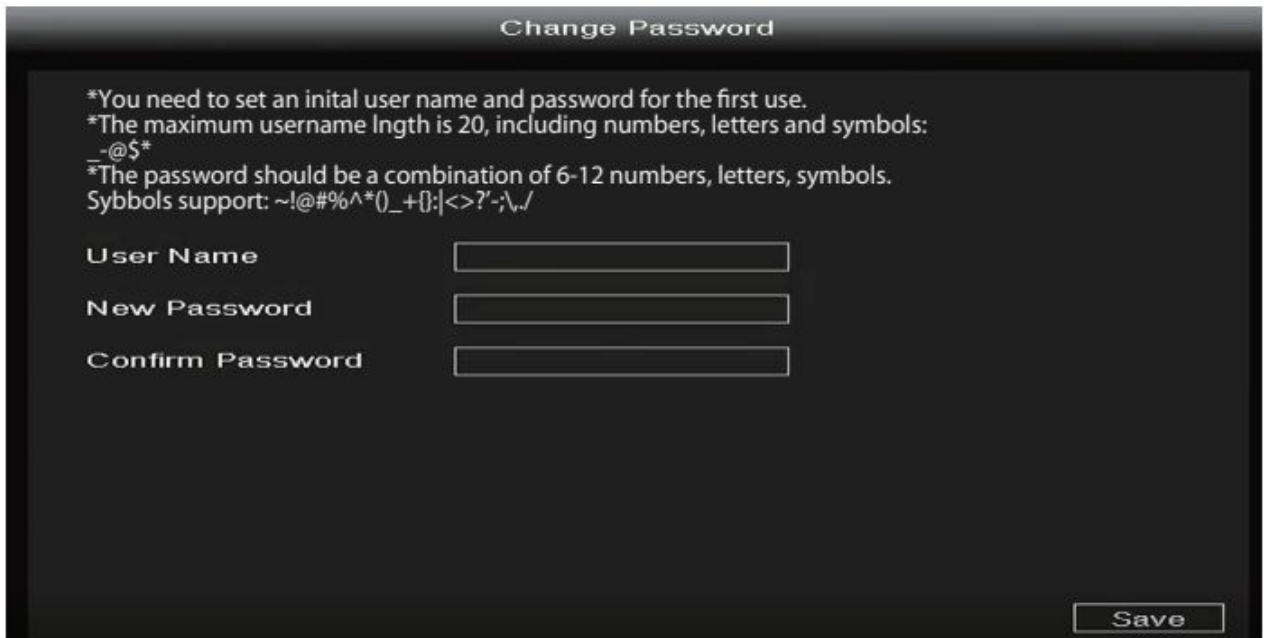

Login page.

Enter the Username and Password, then click on the **OK** button. You will be taken to the Setup Wizard.





## 2.3 Guide

By default, the Guide starts once the NVR has loaded. The Guide can walk you through some important settings of the NVR. If you don't want to use the Guide at that moment, right click the mouse to quit.

1. Setting the system time, date format, language, resolution of the monitor and so on.



2. Format HDD.

Click the **Format** button to set up the HDD. Note that this will delete all files on the HDD.

HDD Full Setting. Select Stop Record or Overwrite.

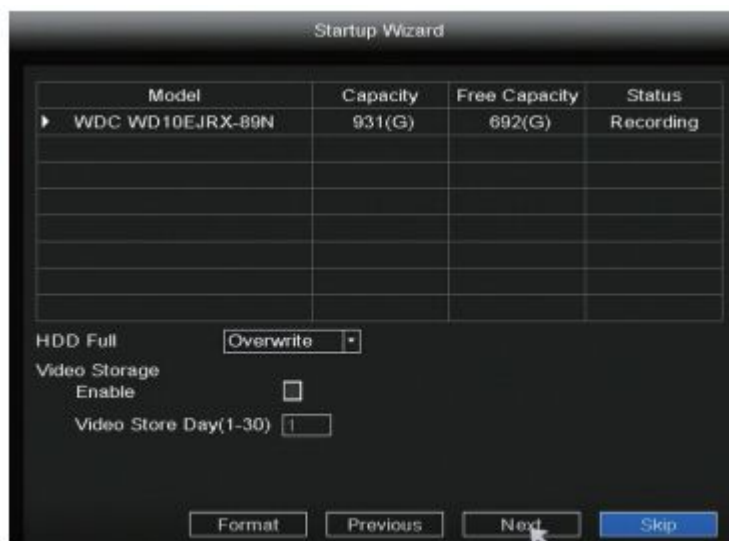

Note

Only FN9108E-B4-2T kit and FN9108E-T4-2T has a 2T hard drive installed at the factory.

3. P2P.

If you want to know the UID of the device, please scan the QR code. If you don't want to use the Setup Wizard next time, check **Not show again** checkbox. Click the Finish button to complete the setup wizard.



or Right-click→ Main Menu → Conguration → uncheck the Setup Wizard checkbox.

Click the Finish button to complete the setup wizard.

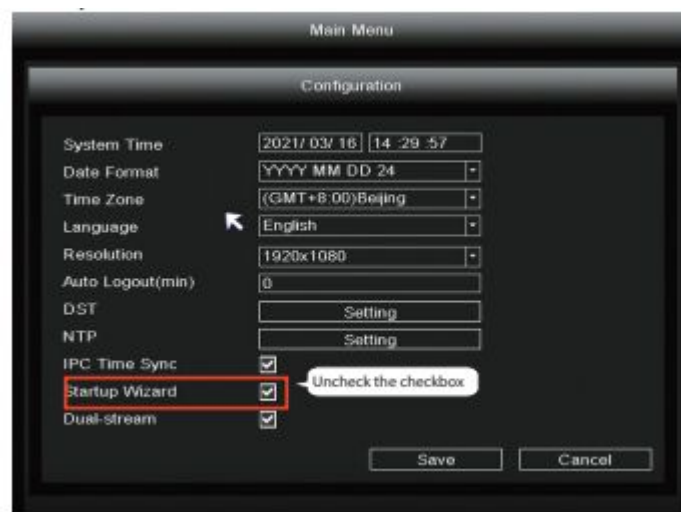

 **Note**

The P2P in this article is only an example, please refer to the actual situation.

You can also Right-click “Main Menu > Configuration”, uncheck the **Startup Wizard** checkbox.

Click the **Save** button.

## 2.4 Shortcut Menu

After login, right-click the mouse, you will enter the shortcut menu.



Right-click in live view mode and select screen from the Shortcut Menu, you can choose 4-screen, 8-screen or 9 screens.

### 2.4.1 Channel Config

#### Channel Config

Right-click in live view mode and select **Channel Config** to enter the **Channel Config** interface, On this page you can see device status such as channel, Status, IP Address, MAC Address, Add IP Camera, Modify IP, Delete/Modify/move up/move down added device.

You can add an IP Camera that is connected to the internet on the NVR.

**Step 1:** Right-click on main interface, select Channel Config.

**Step 2:** Select your IP Camera or Auto added IPC.

**Step 3:** Click **Add**.

**Step 4:** Enter username and password of the camera. If your camera is in the factory default state, you do not need to enter the user name and password.

**Step 5:** Click OK.

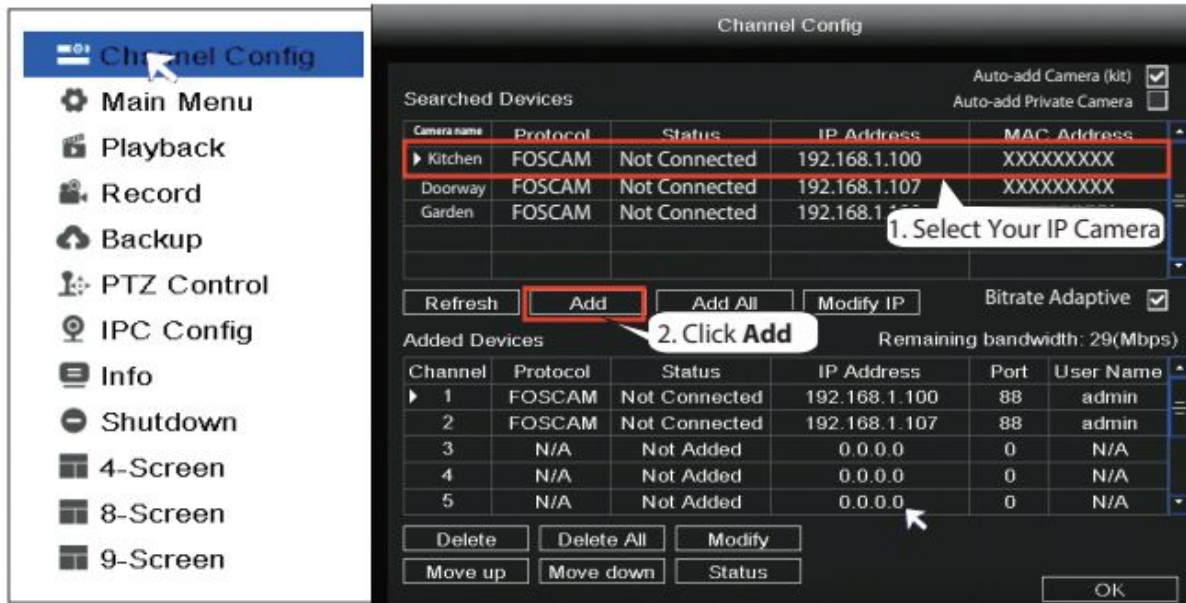

**Note:** If the camera is added during factory default status, the username and password will be the same as the NVR.

Select a protocol depending on which IP Camera you have.

- FOSCAM protocol: The High Definition (HD) IP Cameras for Foscam.
- ONVIF protocol: IP Cameras which support ONVIF protocol.

## 2.4.2 Main Menu

Right-click in live view mode and select **Main Menu** to enter the **Main Menu** interface, it includes Configuration, Display, Record, Backup, Network, HDD, User, Event, Restore, Upgrade, IPC Config, please refer to **2.5 Main Menu**.

## 2.4.3 Playback

You can display the video of every a channel for playback.

Right-click in live view mode and select **Playback** to enter interface. It supports single-screen, four screens or nine screens.



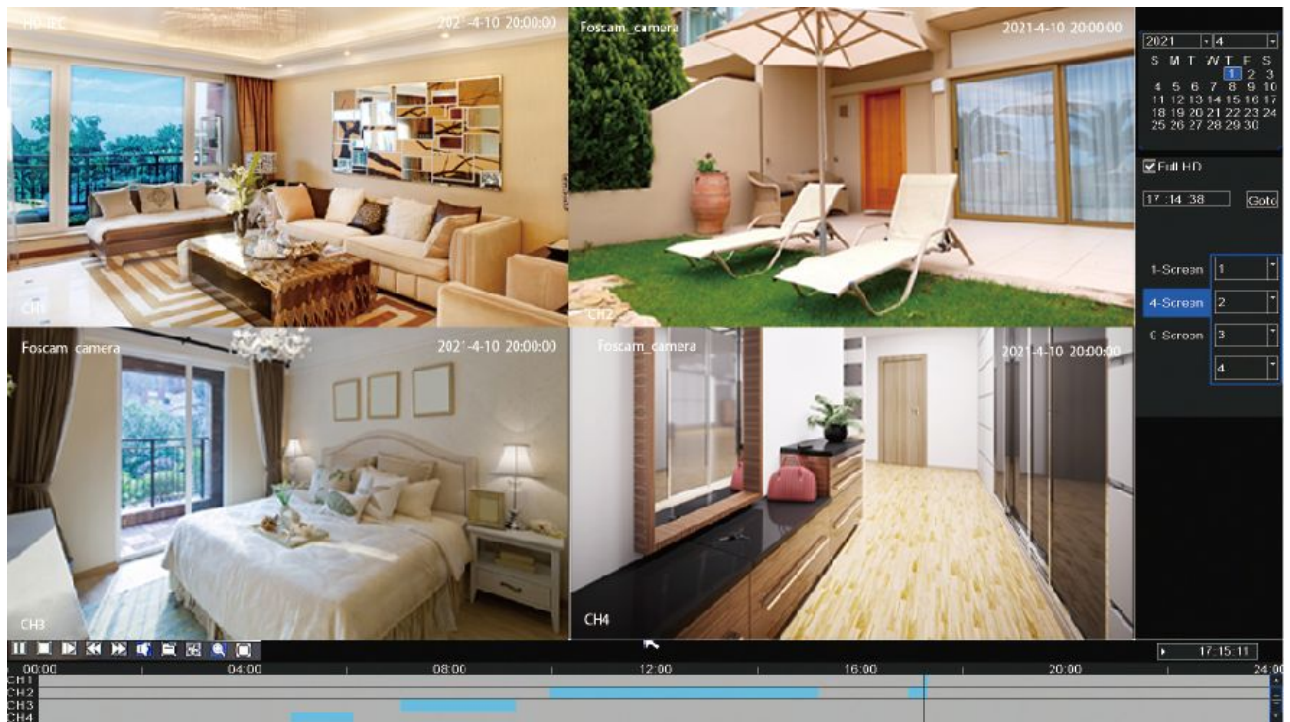

On this page you can view the record files stored in the hard disk.



1. Select a date with recording in calendar.
2. Check the checkbox from Channels. You can select up to nine channels for playback at the same time.

### Manage the recording

Button	Description
	After select the matched recorded file, click the button to play or pause.
	Stop
	Single Frame
	Fast backward. The fast backward speed can be 4 times, 8 times or 16 times of the normal playing speed. Click this button. The multiple of normal playing speed is displayed in the lower right of the fast backward icon. For example,  indicates the current fast backward speed is four times of the normal speed.
	Fast forward. The fast forward speed can be twice, 4 times, 8 times or 16 times of the normal playing speed. Click this button. The multiple of normal playing speed is displayed in the lower right of the playback page. For example,  indicates the current playing speed is four of the normal

	speed.
	Audio
	Backup. Click this button and you will go to the backup page
	Cut. See below the table for details.
	Log. Click this button and you will go to the log page.
	Full Screen

**Cut**

**Step 1:** Click , you will go to the **Cut** interface.

**Step 2:** Choose the **Channel**, **Type**, **Date**.

**Step 3:** Click **Search** to find the recordings available.

**Step 4:** Select **Add Flag**, then double-click left mouse to select the start time and end time.

**Step 5:** Insert USB flash drive to the USB port located at the rear of your NVR.

**Step 6:** Click **Backup** button to save the video information to the USB flash drive. Tips are available after the backup is complete





## 2.4.4 Record

After the IP Camera is added successfully to the NVR, enable Scheduled Record functionality to the following methods when in the Live View mode.

### 2.4.4.1 Scheduled Record

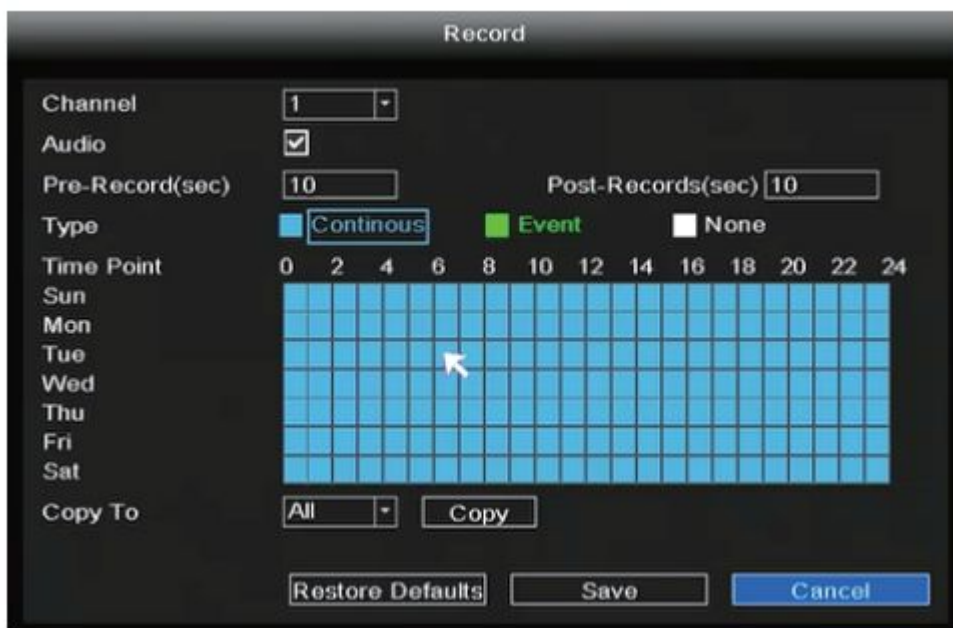
Right-click → Main Menu → Record → choose recording channel → Save (Actually, the NVR system have default set 24h scheduled recording).



In the Live View mode, the icon  is at the bottom right of the screen for each channel, indicating recording is on going.

### 2.4.4.2 Event Record

If you want to start event recording, select Event in Type, use the left mouse button to select the time (turned to green), if the other channels operate in the same way, select Copy.



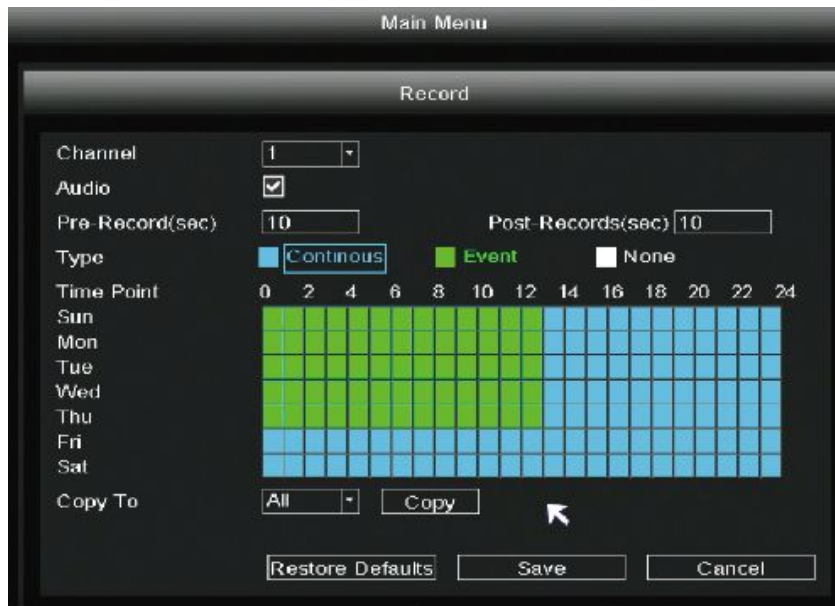



Note: The default alarm type is Motion Detect.

In the Live View mode, the icon is at the bottom right of the screen for each channel, indicating recording is on going, and different icons indicate different detection.

 : Motion detection

 : Human detection

 : Vehicle detection

If you want to check the record, right-click in live view mode and select “**Main Menu > Playback**”. Choose channel and date, then click timeline to check record.

Set the event alarm according to the following method: Right-click → Main Menu → Event → Motion Detect → choose target channel, setting Schedule, Delay, Record Channel, Tour, PTZ Activation, Send Email Buzzer → Save.



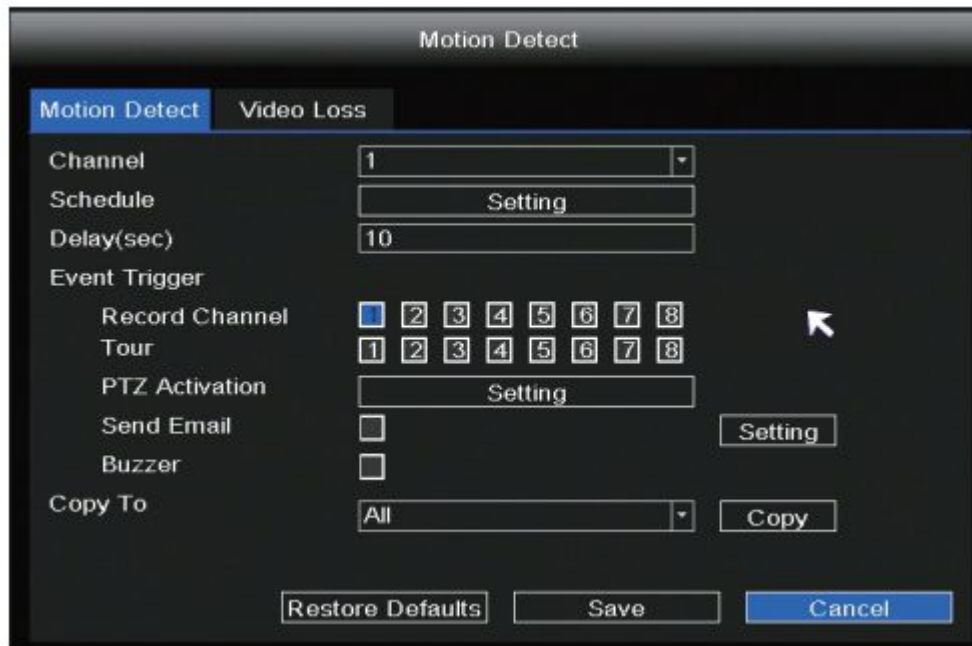

## 2.4.5 Backup

Insert USB flash drive to the USB port located at the rear of your NVR.

Right-click in live view mode select **Backup** to enter the **Backup** interface.

**Step 1:** Choose channel, type and time.

**Step 2:** Click **Search** button.

**Step 3:** Select target file.

**Step 4:** Click **Backup** button to finish backup.



### Note

If target file can not be searched out, please click empty to add. Please remove the files which is no need before backup. Ensure insert device (like USB) in 30 second, as system reserved searching time for it is 30 second.

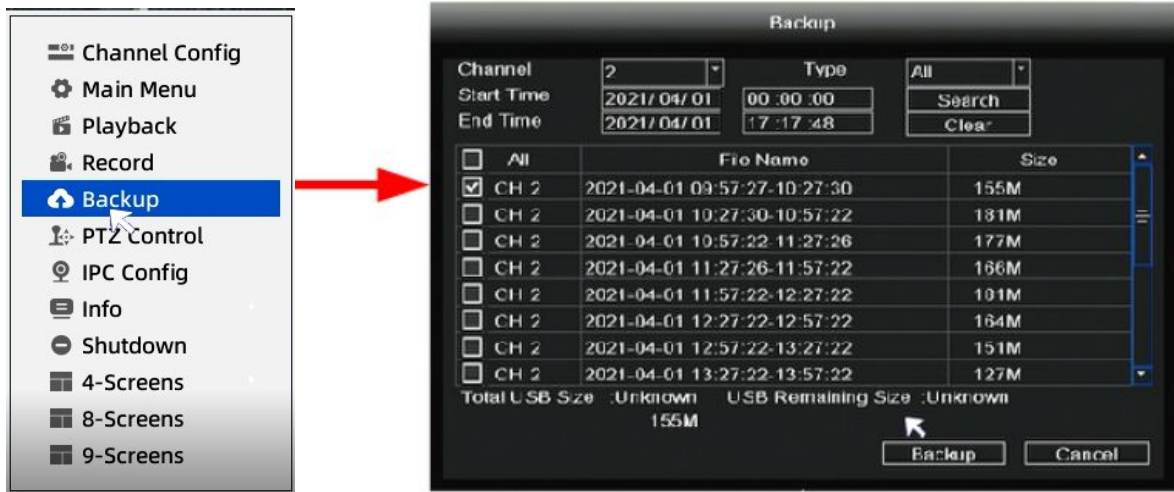

## 2.4.6 PTZ Control

NVR can operate the lens steering of IPC, which must support PTZ function.

## 2.4.7 IPC Config

Right-click in live view mode and select **IPC Config** to enter the **IPC Config-1** interface. You can set the Image, OSD, Encode, Advanced, Maintenance for the IPC.

### Image

Choose **Image** to enter the **Image** interface, On this page you can adjust the image color mode of the monitor channel.

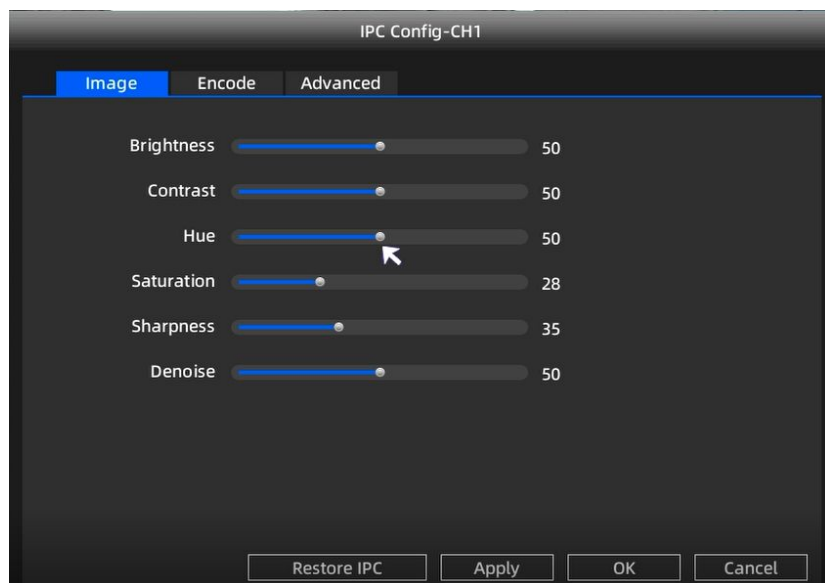

## Encode

Choose **Encode** to set the information for the main stream and the sub stream.



### Note

You can choose to configure mainstream/sub stream information based on the network environment.

	Main Stream	Sub Stream
Coding Mode	H265	H264
Resolution	3072x1728	640x360
Bitrate Control	VBR	VBR
I Frame Interval	40	40
Bit Rate(kbps)	1536	512
Frame Rate(FPS)	20	20

## Advanced

**Step 1:** Choose **Motion Detection**.

**Step 2:** Set Sensitivity, Low, Middle, High.

**Step 3:** Click on the **setting** button, set alarm area.

**Step 4:** Set **Night Vision**, default to Auto.

**Step 5:** Set up Vehicle, Human body, White light, and Sound and Light alarm linkage according to your own needs.

**Step 6:** Click **Apply** button.

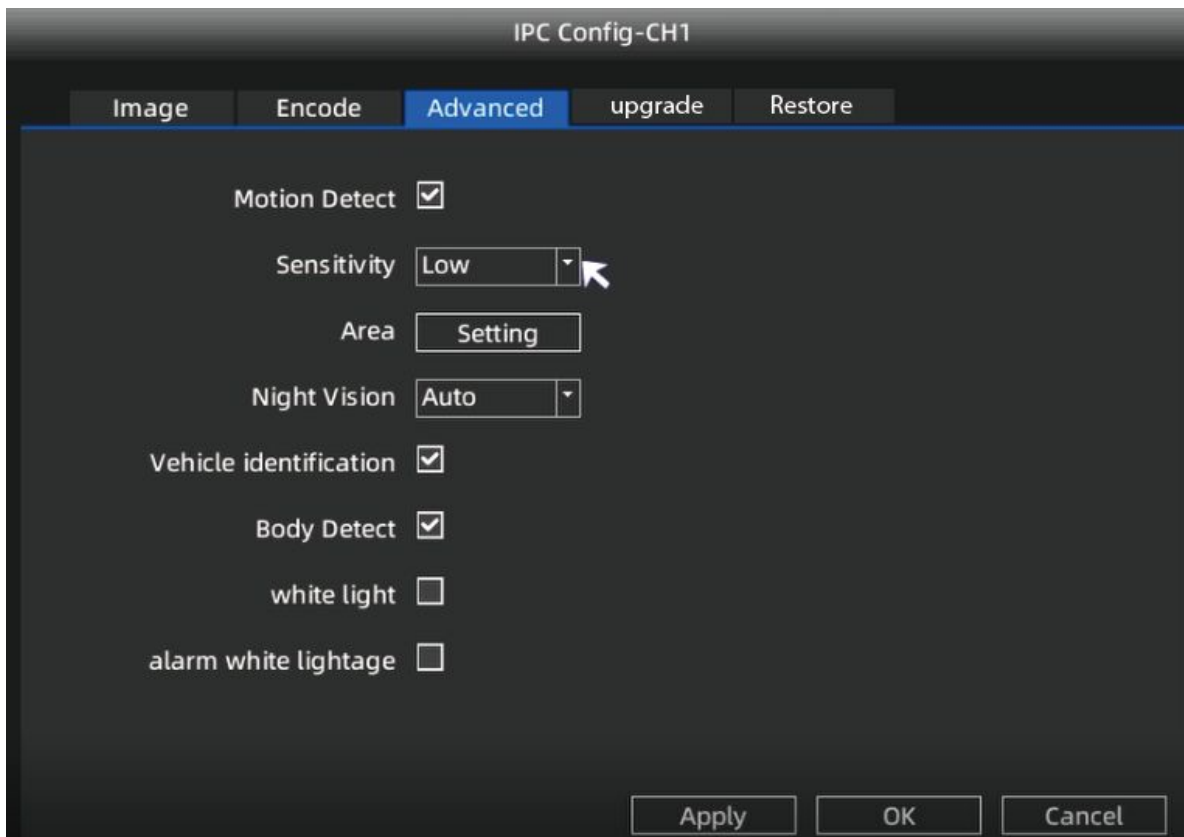

## Upgrade

**Step 1:** Download the firmware to the U disk.

**Step 2:** Insert U disk to NVRUSB port.

**Step 3:** click **Refresh**.

**Step 4:** click **Upgrade** to upgrade your camera.

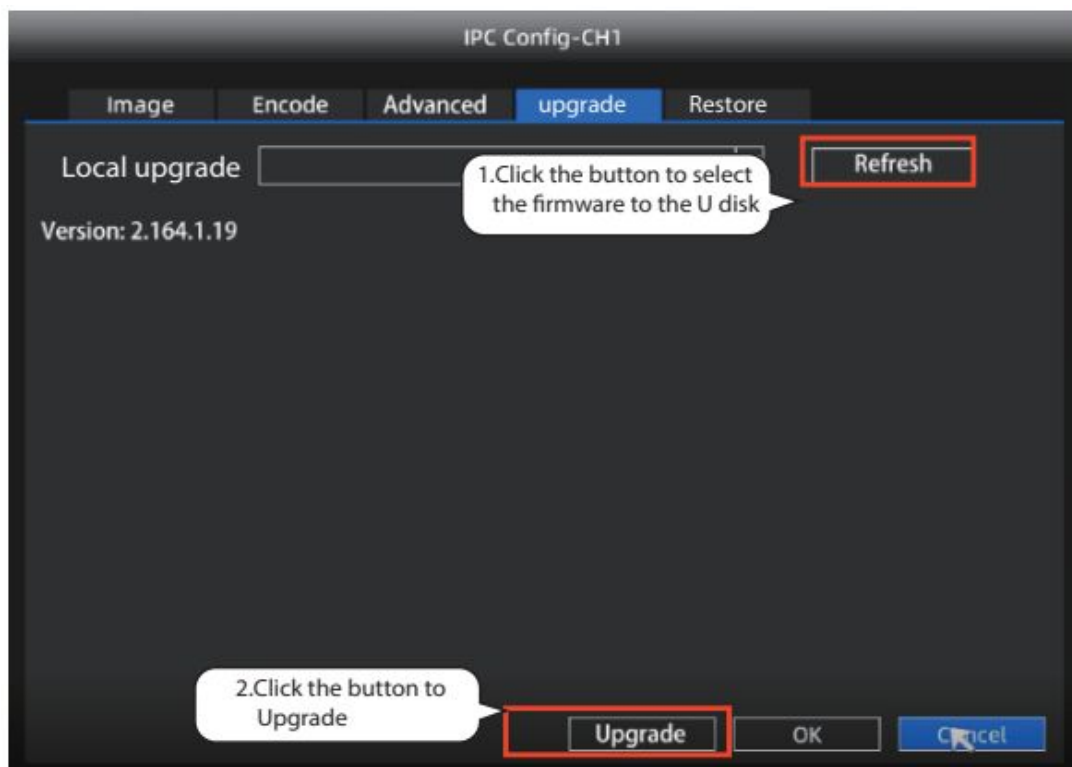

## Restore

**Step 1:** Choose **Restore factory settings**.

**Step 2:** click **Apply** to restore factory settings your camera.

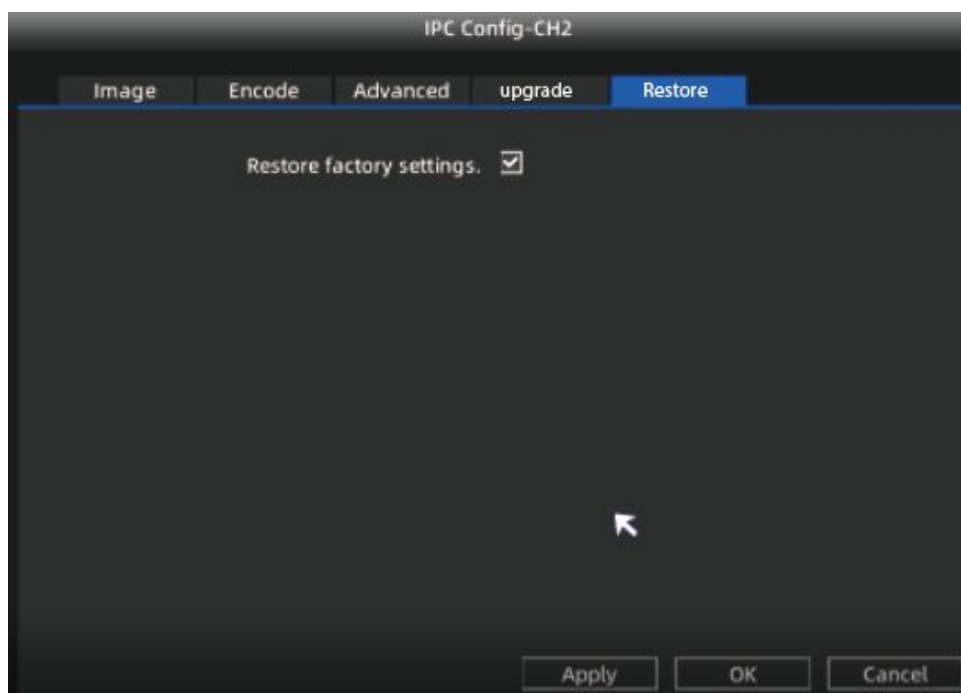

## 2.4.8 Info

Right-click in live view mode and select “**Info > log**”, you can search the log information of the NVR. The log record shows recording time and accessed information.

If you want to back up the log information, please insert USB flash drive to the USB port located at the rear of your NVR, and then click the **Backup** button.

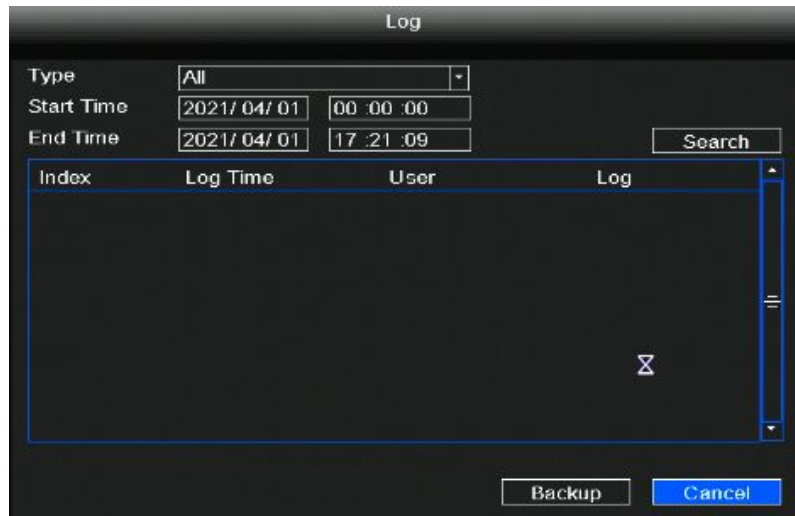

Right-click in live view mode and select “**Info > Version**”, you can view the version information of the NVR.

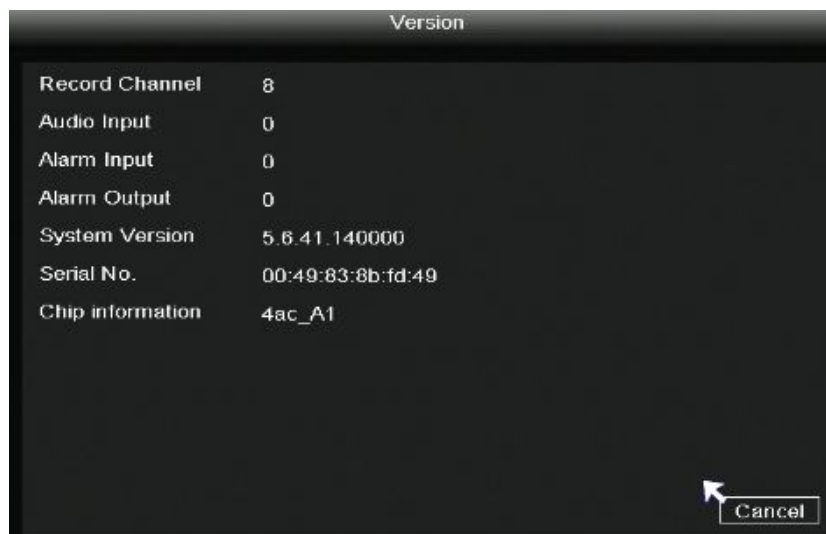

### Note

The data in the figure is only an example, please refer to the actual situation.

## 2.4.9 Shutdown

Right-click in live view mode select **Shutdown** to enter the **Shutdown** interface. You can restore, logout, reboot or shutdown the NVR system.



Click **Restore**, The **Restore factory settings** interface is displayed. You can check some information to restore the factory settings, as shown in the figure below.



### Note

Each model is slightly different, please refer to the actual interface.

## 2.5 Main Menu

Right-click in live view mode and select **Main Menu** from the **Shortcut Menu**, the **Main Menu** interface is displayed.

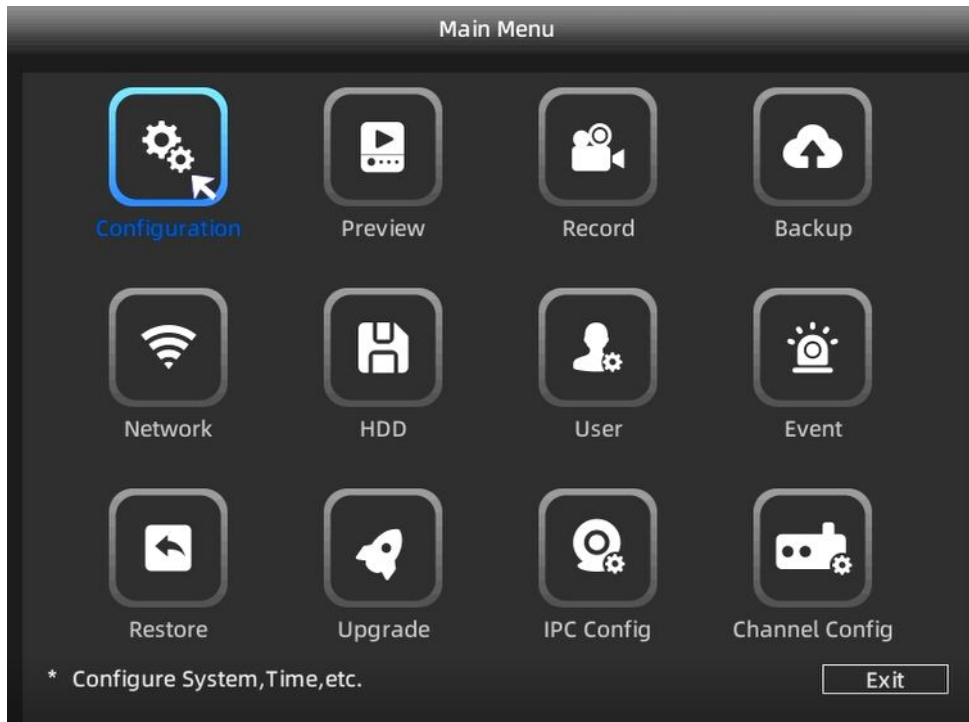

## 2.5.1 Configuration

Right-click in live view mode and select “**Main Menu > Configuration**” in the Main Menu interface. The **Configuration** interface is displayed. You can set the system time, date format, language, resolution of the monitor and so on.



If you don't want to display the startup wizard every time you turn it on, please uncheck the **Startup Wizard** checkbox.



## 2.5.2 Preview

### Preview

Right-click in live view mode and select “**Main Menu > Preview**” in the Main Menu interface. The **Preview** interface is displayed. You can set the Channel Title, Time Title, Channel Title, Record Status, Alarm Status.

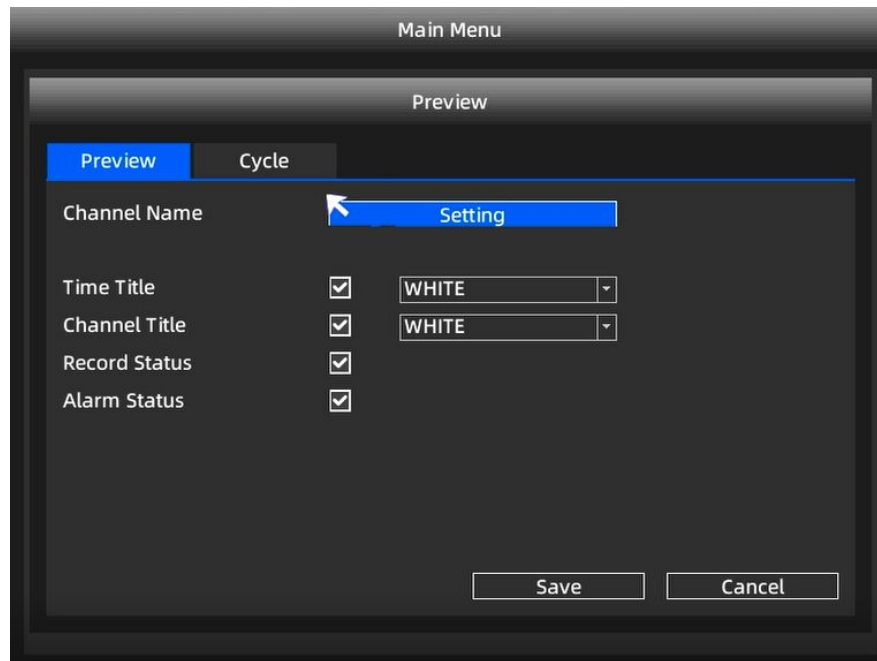

### Cycle

Right-click in live view mode and select “**Main Menu > Preview > Cycle**” in the Main Menu interface. The **Cycle** interface is displayed.

After the user sets the cycle function, NVR will play several channels of video on the display at the same time according to the interval time set by the user. After each channel plays for a few seconds, it will automatically jump to the next group of channels for cyclic playback.

**Step 1:** Check the Enable.

**Step 2:** Set the Event Interval(sec).

**Step 3:** Click the add button to select which channel videos can be played within each group.

**Step 4:** Click **Save** button.

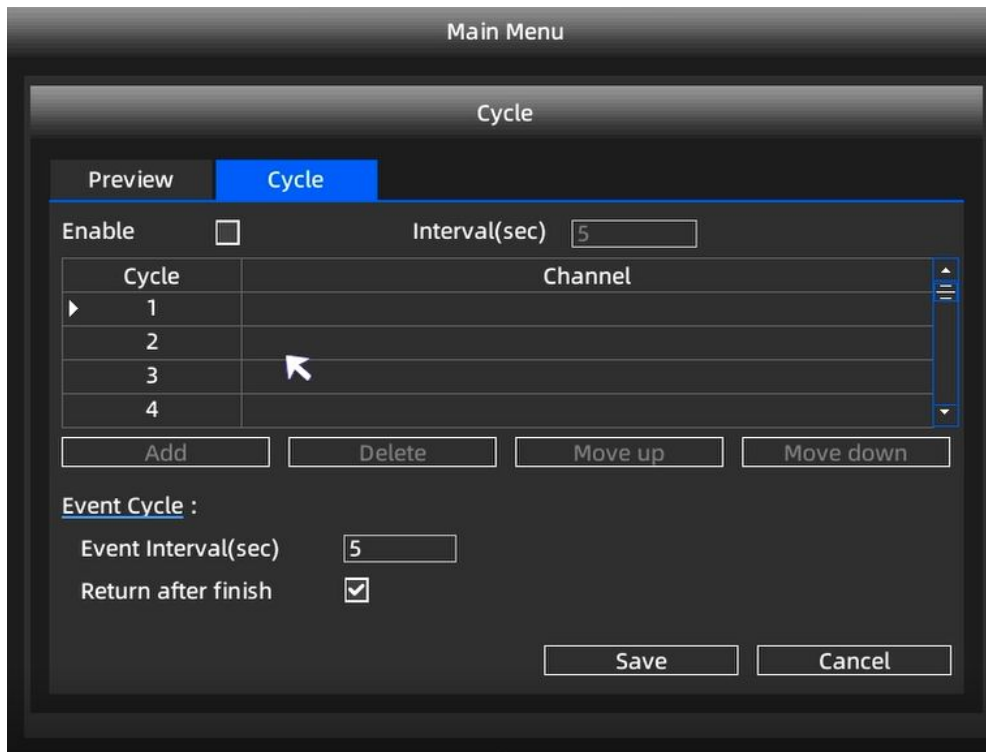

### 2.5.3 Record

Right-click in live view mode and select “**Main Menu > Record**” in the Main Menu interface. The **Record** interface is displayed. Choose recording channel, click **Save** button. (Actually, the Wi-Fi NVR system have default set 24h scheduled recording).

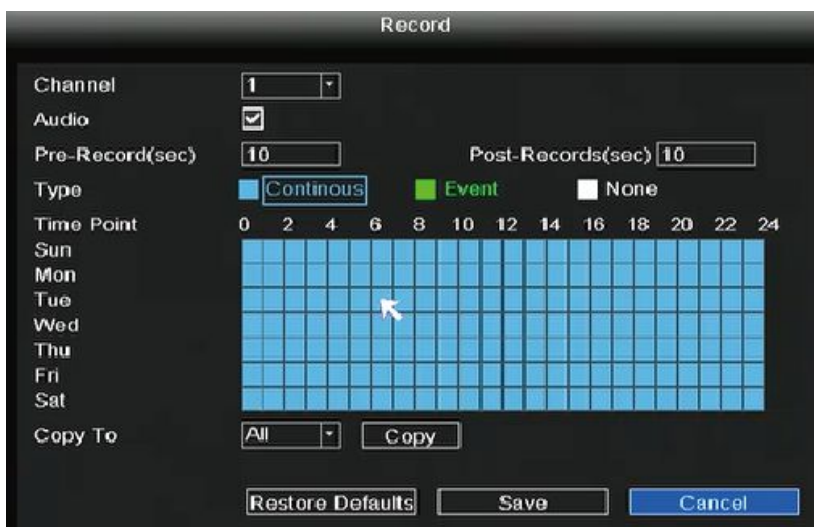

If you want to modify it to alarm recording, please use the left mouse button to select the time (turned to green), if the other channels operate in the same way, select copy.

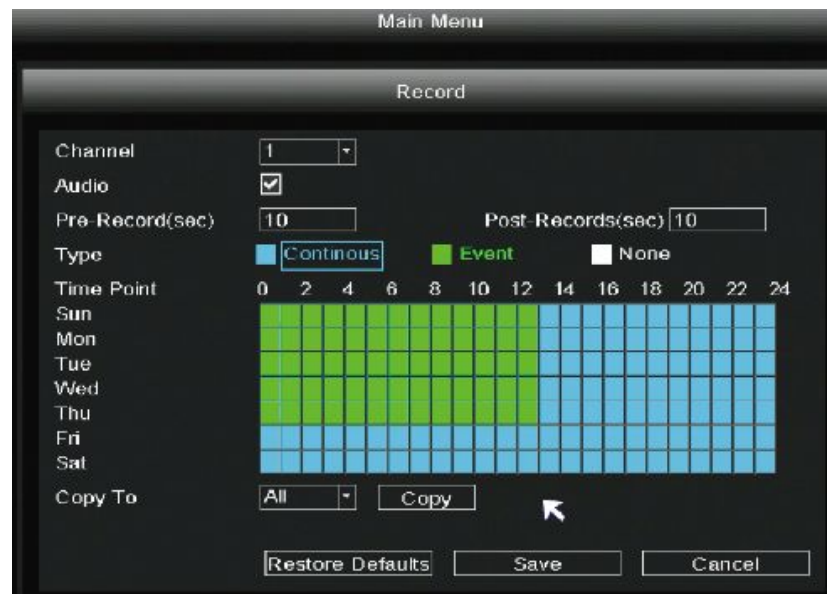

## 2.5.4 Backup

- Step 1:** Insert USB flash drive to the USB port located at the rear of your NVR.
- Step 2:** Right-click in live view mode and select “**Main Menu > Backup**” in the Main Menu interface. The **Backup** interface is displayed.
- Step 3:** Choose channel, type and time, Click **Search** button.
- Step 4:** Select target file.
- Step 5:** Click **Backup** button.

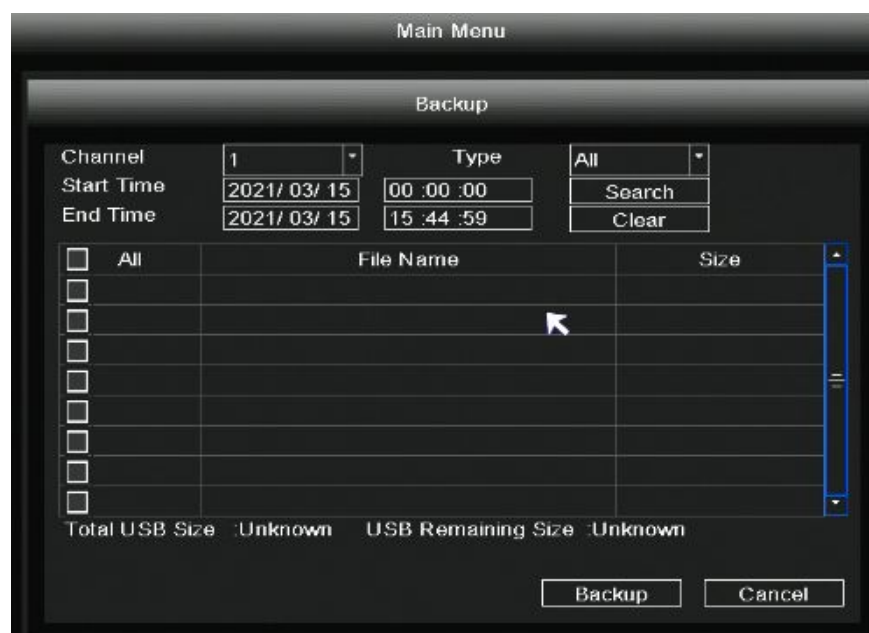



### Note

If target file can not be searched out, please click Empty →Add. Please remove the files which is no need before backup. Ensure insert device (like USB) in 30 second, as system reserved searching time for it is 30 second.

## 2.5.5 Network

Right-click in live view mode and select “**Main Menu > Network**” in the Main Menu interface. The **Network** interface is displayed.



### Note

The UID information here is only an example, please refer to the actual device.

There are two ways for NVR to connect to Internet.

- DHCP: Select **DHCP** from the **Network Type**, the device will connect to Internet automatically, no need data setting.

Note: The NVR DHCP server will open if it does not detect and connect a router within the 30s, which is used for searching and connecting to the IPC on the PoE NVR or switch. If a router is connected at this time, the NVR cannot be found when adding it by APP or VMS, and the NVR needs to be restarted.

Remarks: Users can customize the startup time or close of the NVR DHCP server.

- Manual setting: Select **STATIC** from the **Network Type**, fill in IP address, DNS data, and so on, click **Save** button.

If user doesn't familiar about the network environment, please prefer use DHCP first.

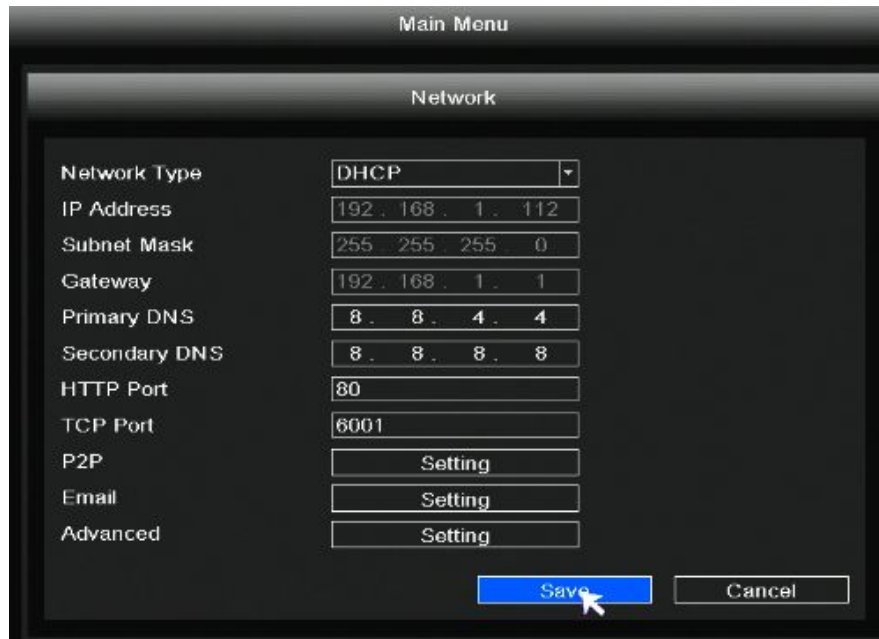

Click **Setting** in **P2P**, you can scan the UID of the device through the app, add and remotely manage the device.



Click **Setting** in **Email**, you can set Email information.

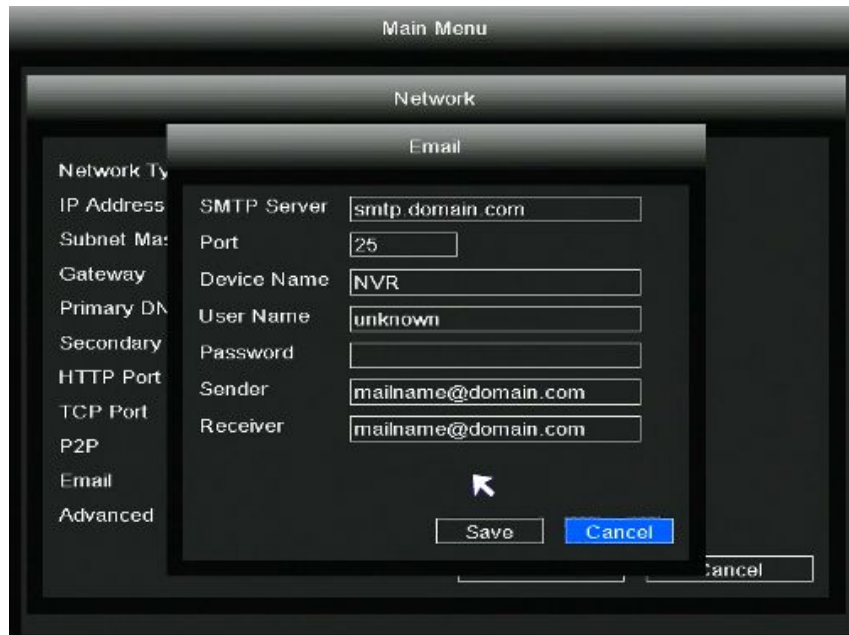

Click **Setting** in **Advanced**, you can set **PPPOE**, **DDNS**, **DHCP Sever**.

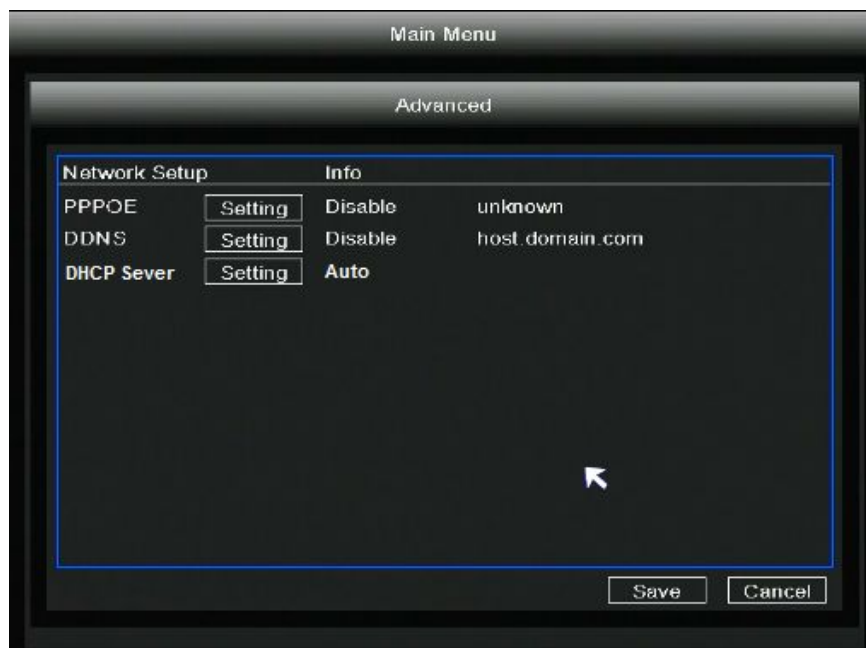

## 2.5.6 HDD

Right-click in live view mode and select "**Main Menu > HDD**" in the Main Menu interface. The **HDD** interface is displayed.

When the HDD is full, you can select the cycle cover the earliest recording or stop recording.

You can set the video storage time.

Click the **Format** button, you can also format the hard drive.

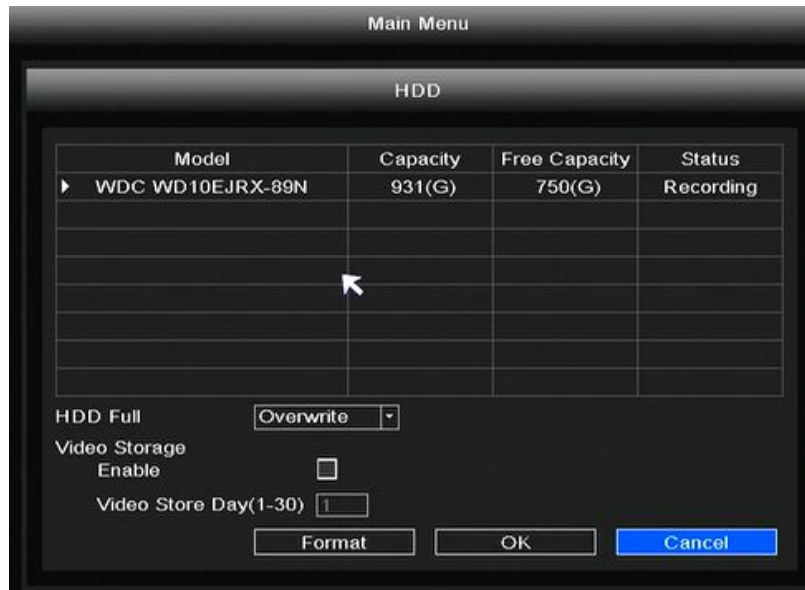

## 2.5.7 User

Right-click in live view mode and select “**Main Menu > User**” in the Main Menu interface. The **User** interface is displayed.

You can add user, delete user, modify user and change password.

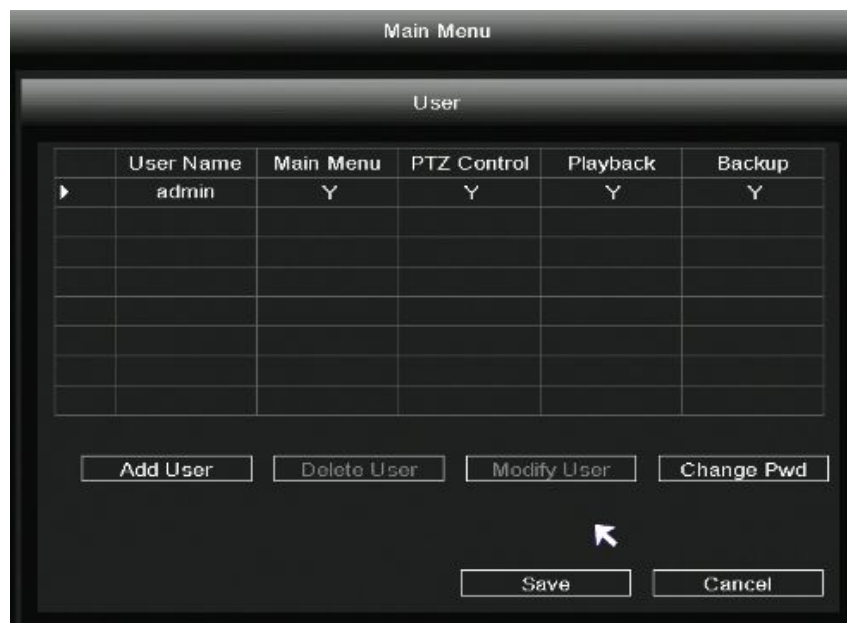

### Add User

Click **Add User** to enter the **Add User** interface, On this page you can add to user, user password and Authority Option.

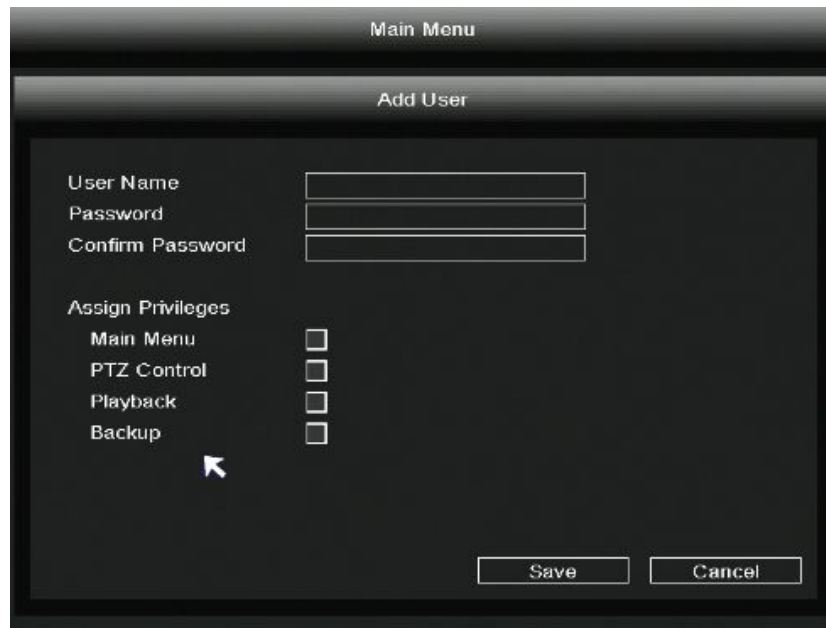

Main Menu

Add User

User Name

Password

Confirm Password

Assign Privileges

Main Menu

PTZ Control

Playback

Backup

Save Cancel

### Modify User

Click **Modify User** to enter the **Modify User** interface, On this page you can change user password and authority option.

### Delete User

Click **Delete User** button to delete a user.

### Change Pwd

Click **Change Pwd** button to change password.

## 2.5.8 Event

### Motion Detect

Right-click in live view mode and select "**Main Menu > Event**" in the Main Menu interface. The **Motion Detect** interface is displayed. On this page you can setting Channel, Scheduled, Delay and Event Trigger mode.

Set the event alarm according to the following method:

**Step 1:** Choose target channel.

**Step 2:** Setting Schedule and Delay.



**Step 3:** Select the Event Trigger. You can choose the following alarm triggering methods: Record Channel, Tour, PTZ Activation, Send Email, Buzzer. If you want to set other channels to be the same, you can select the "Copy To" , then click **Copy** button.

**Step 4:** Click **Save** button to take effect.

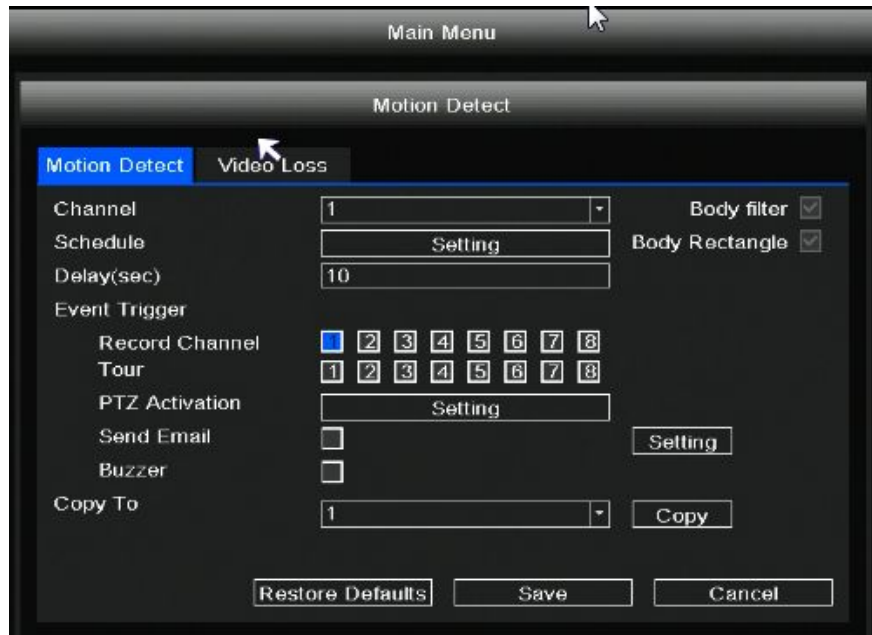

## Video Loss

Click **Video Loss** to enter the **Video Loss** interface. When there is no video in the channel, the NVR alarm function is triggered. On this page you can setting Channel, Schedule, and Event Trigger.

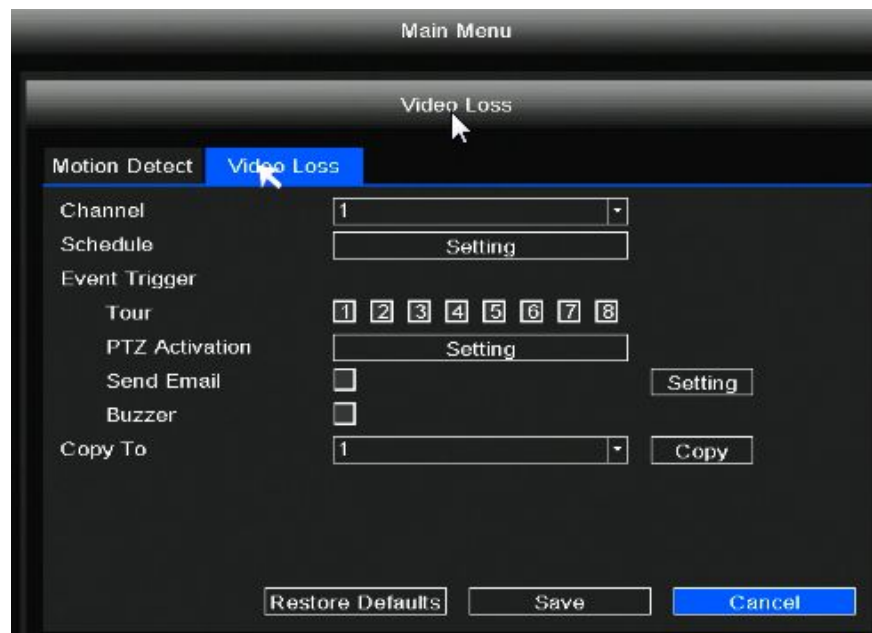

If you want to set other channels to be the same, you can select the "Copy To" , then click **Copy** button.

## 2.5.9 Restore

Right-click in live view mode and select "**Main Menu > Restore**" in the Main Menu interface. The **Restore factory settings** interface is displayed. On this page you can choose which you can restore the factory settings.



## 2.5.10 Upgrade

You can upgrade your NVR system with local Software.

**Step 1:** Download the firmware to the USB flash drive.

**Step 2:** Insert USB flash drive to the USB port located at the rear of your NVR.

**Step 3:** Right-click in live view mode and select "**Main Menu > Upgrade**" in the Main Menu interface.

**Step 4:** Click **Refresh** button in the **Upgrade** interface.

**Step 5:** Select the firmware from the USB flash drive.

**Step 5:** Click Upgrade to upgrade your NVR.

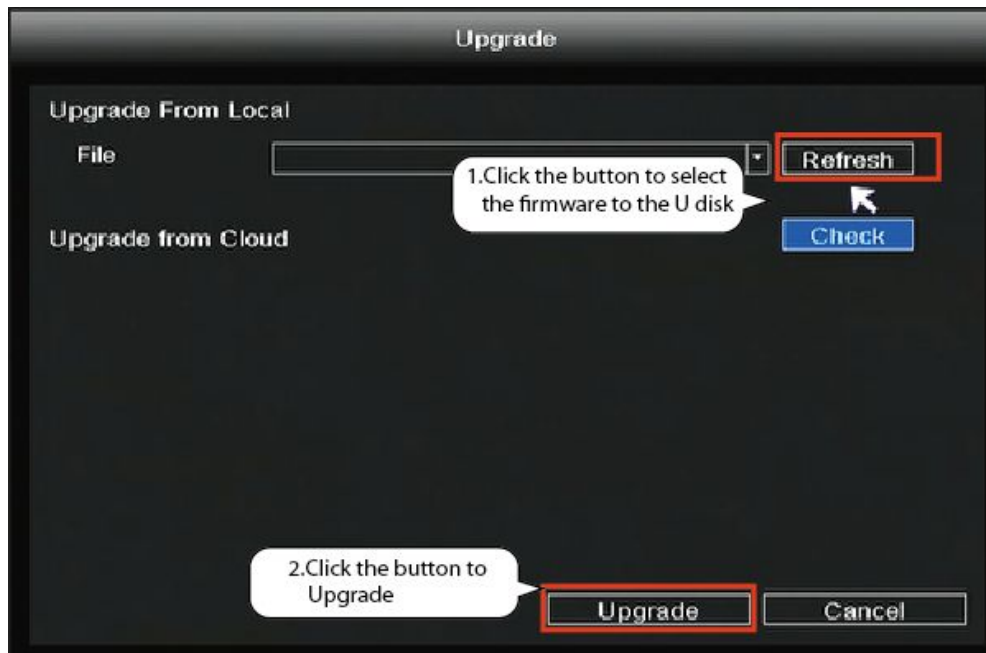

 **Note**

Don't shut down the power during upgrade. After upgrading, NVR restarts.

## 2.5.11 IPC Config

Right-click in live view mode and select “**Main Menu > IPC Config**”, you can set the Image, OSD, Encode, Advanced, Maintenance for the IPC. For detailed operation, please refer to 2.4.7 IPC Config.

## 2.5.12 Channel Config

Right-click in live view mode and select “**Main Menu > Channel Config**” to enter the **Pair IP Camera** interface . please refer to 2.4.1 Channel Config.

## 3 Access the NVR in Foscam App

---

### 3.1 Download the Foscam APP

Please refer to the **Quick Setup Guide** if you install the NVR for the first time. You can start to learn about software operation after finish quick installation.

Scan the QR code below to download and install the Foscam APP.



### 3.2 Create A Foscam Account

You can create a Foscam account for the first time. Run the Foscam APP, and then register for a Foscam account.

**Step 1:** Click Foscam app icon to enter the login page. Click **Sign Up** to create account.

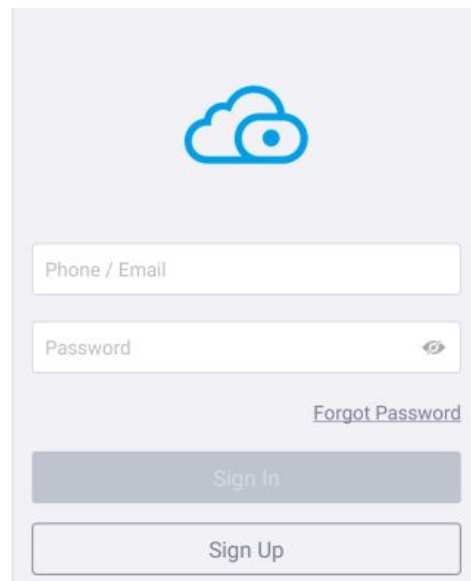

**Step 2:** You need to choose your region, then enter the mailbox name and new password.

**Step 3:** Check **Accept Privacy Notices and Terms of Service**, and click **Sign Up**.

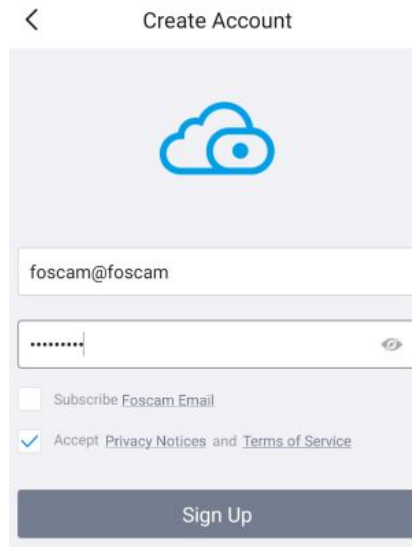

**Step 4:** The system will send activation information to your mailbox, and you need to log in to your mailbox to activate your account.

### 3.3 Add Device in Foscam App

Open the foscam APP and please sign in if you have one already. After logging into Foscam APP, select "+" icon on the upper right corner. The Add Devices interface is displayed.

 **Note**

Please make sure that the NVR and your phone are both in the same Local Area Network (LAN).

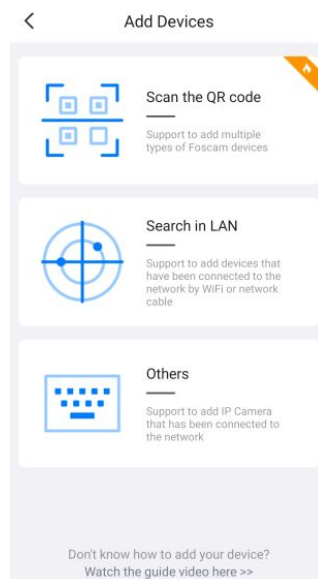

You have the following methods to add devices.

- Select "Scan the QR code" and scan the QR code that labeled at the bottom of your NVR.

- Select “Search in LAN” to search for the device.
- Select “Others”, You can manually add device information in three ways: UID/DDNS/IP Address.

 **Note**

Neither FN9108E-B4 kit/ FN9108E-T4 kit nor FN9108H/9108HE supports DDNS connection.

After the addition is successful, NVR video will be displayed in the Foscam app.

## 3.4 Foscam APP Surveillance Window

You can start to learn about software operation after finish quick installation. When you launch the Foscam App, the devices page displays.

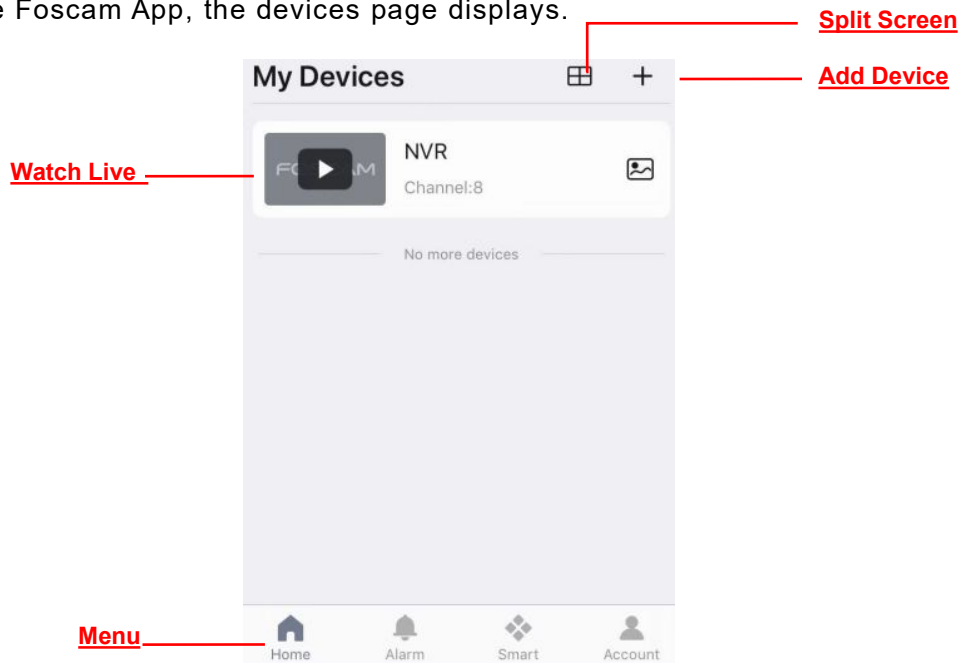

Click  button, you can watch the live interface of 4 devices.

Tap **Live**  to view and listen to a live video.

## 3.5 Watch Live

Click device in list to enter preview interface, select a channel to view it's picture, as follow shows:

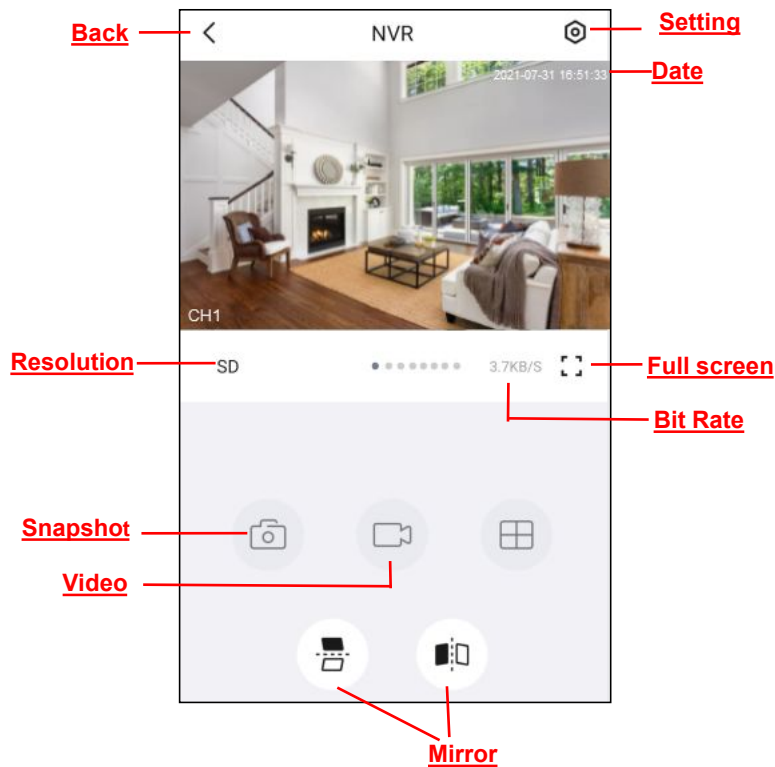

**Back:** To stop viewing and listening to the live feed, tap the Back.

**Resolution:** There are two types to identify different streams you have set. If select the QHD Mode, the clearer video will become, and it will take up more bandwidth; If select the SD Mode, the video will not be as clear as QHD Mode, and it will take up less bandwidth.

If you want to catch the smaller details, pinch and drag any image as you do with photos on your smart phone.

**Snapshot:** Click this button to Snapshot the image.

**Video:** Click this button to start the recording function.

**Setting:** Click this button to set more.

**Date:** Display the date.

**Full screen:** Click this full screen button, you can live in full screen.

**Bit Rate:** You can see the current connection bit rate.

**Mirror:** You can flip the image horizontally/vertically with this button.

## 3.6 Setting

Tap  the button, goes to Settings to make advanced NVR settings.

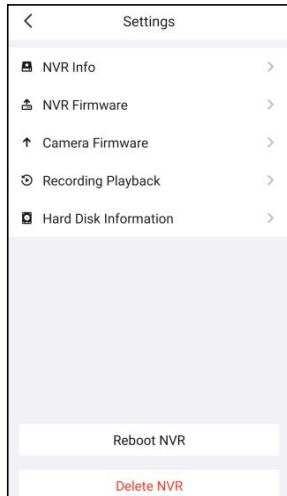

### 3.6.1 NVR Info

You can modify the NVR name. You can also see the basic information of the NVR through this, such as NVR model, UID, MAC ID, NVR firmware version information, IPC firmware version information.



#### Note

The data in the figure is only an example, please refer to the actual situation.



### 3.6.2 NVR Firmware

You can see the current NVR's firmware version and whether there is new software that needs to be upgraded. If there is new firmware, you can click the “Upgrade” button to upgrade.

### 3.6.3 Camera Firmware

You can see the current camera's firmware version and whether there is new software that needs to be upgraded. If there is new firmware, you can click the “Upgrade” button to upgrade.

### 3.6.4 Recording Playback

You can query the recording playback content according to the time, type, and channel.

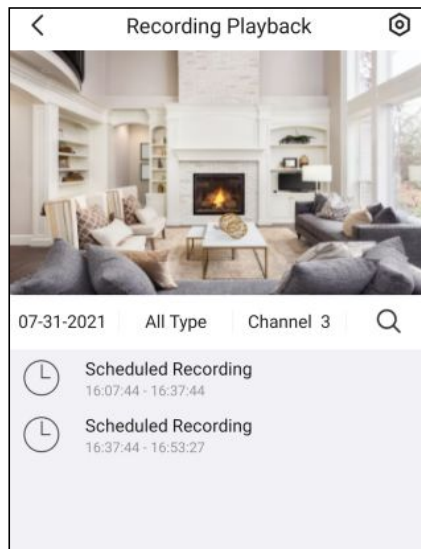

### 3.6.5 Hard disk information

When the HDD is full, you can check the **Loop Coverage** to select the cycle cover the earliest.

You can see the HDD information of the NVR.

You can format the hard information by clicking the **Format the hard disk** button.

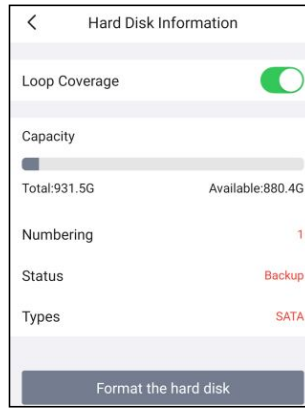

### 3.6.6 Reboot NVR

Click **Reboot NVR** to reboot the NVR. This is similar to unplugging the power to the NVR.

### 3.6.7 Delete NVR

You can click **Delete NVR** button to delete the NVR from the app, or delete and keep history files from the app.

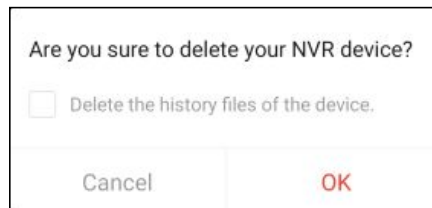

# 4 Surveillance Software Foscam VMS

Foscam VMS is a new tool for PC. It does not require plug-ins and is compatible with Windows & Mac, It supports all Foscam HD cameras and up to 36 cameras at the same time.

It is recommended that you first use the cloud account registered by the Foscam app, and then use the local account.

## 4.1 Software Installation

- 1) Double click the software and follow the setup wizard to install the program.



- 2) The FoscamVMS icon will appear on the desktop automatically after a successful installation.

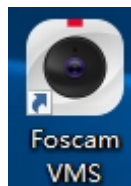

**Note:**

Sometimes the program will be treated as virus, so before installing, please add the software as trusted program on your computer.

## 4.2 Create A Local Account



### Local with Foscaml Account

Click the “Local with Foscaml Account” button and you will create a local account to manage your camera.

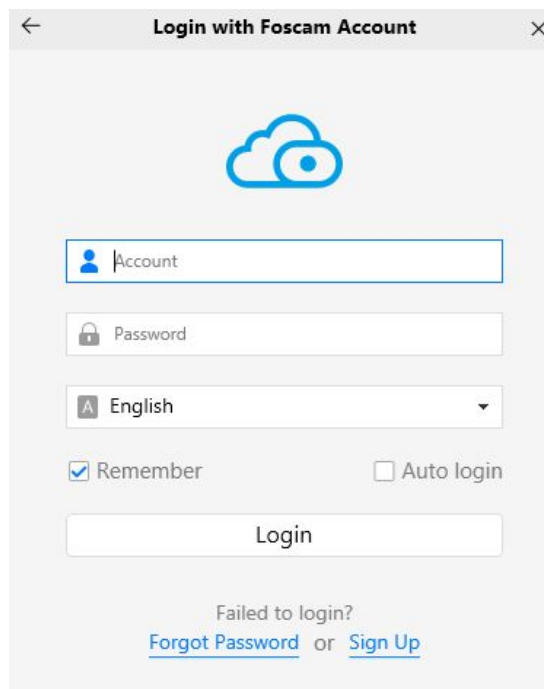

### Login with Local Account

Click the “Login with Local Account” button, and you will need to use the Foscam account and password to log in, which is consistent with the Foscam app account.

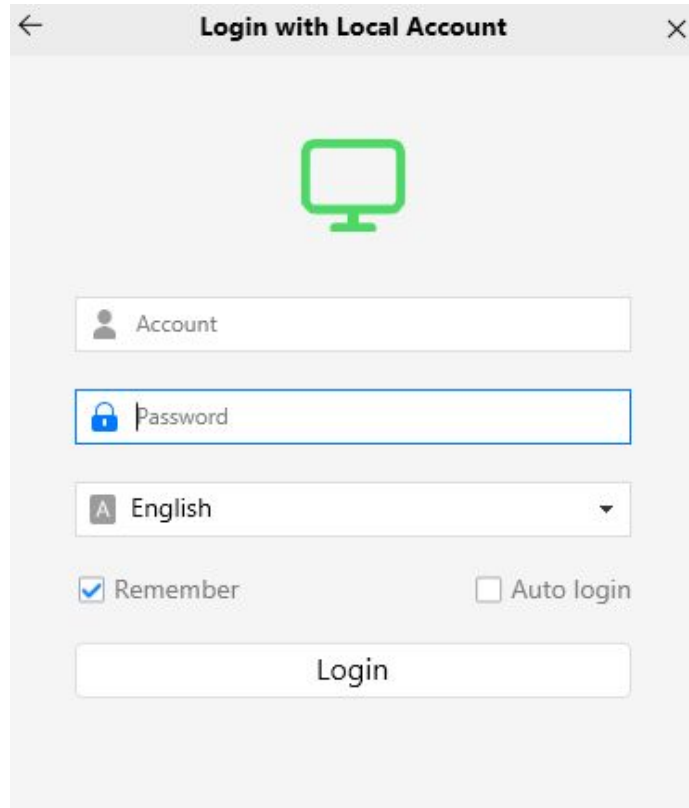

## 4.3 Add Device

If your NVR is wired connect, you can choose the following method to add to Foscam VMS.

### 4.3.1 LAN Add

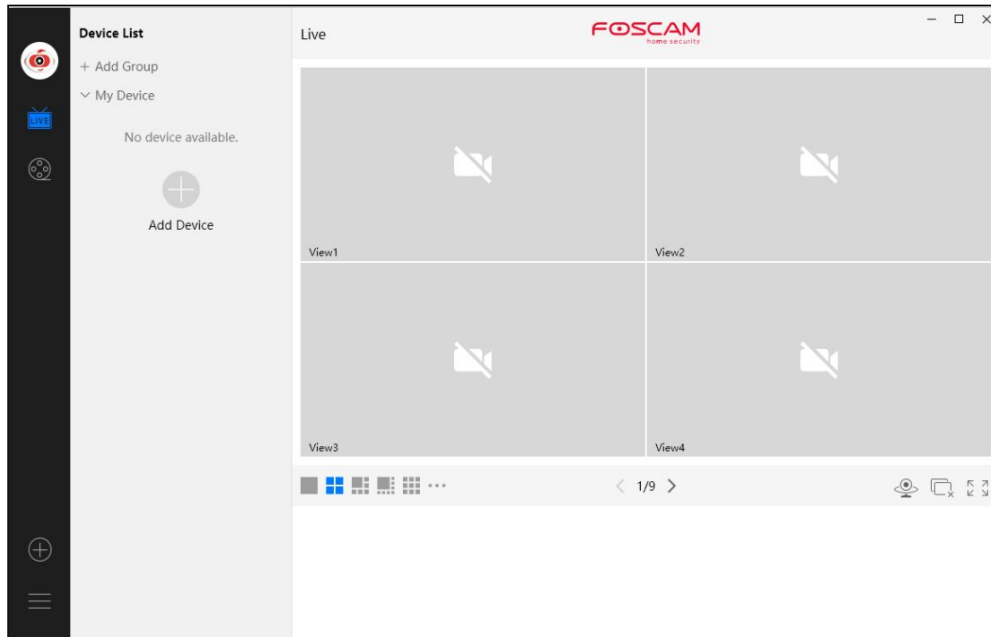

Click **Add Device**  button, then follow below steps:

**Step1** Select “ALL” from the device types.

**Step2** Click the IP address of the NVR on the list, then the name of the NVR and the IP information will be entered automatically.

**Step 3** Click Add.

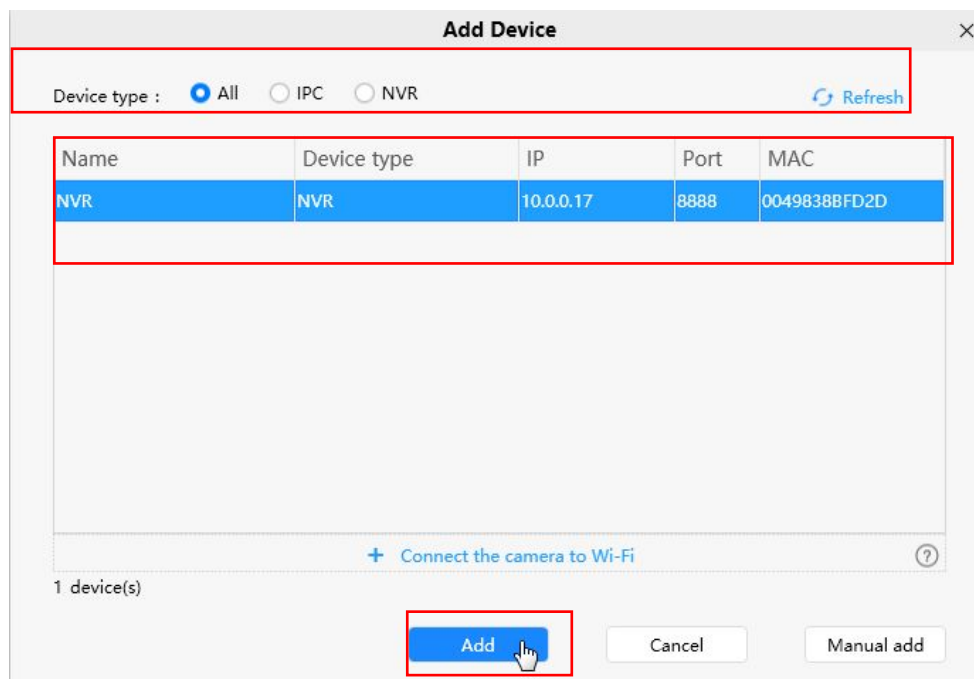

**Step 4** Enter the username and password of the NVR.

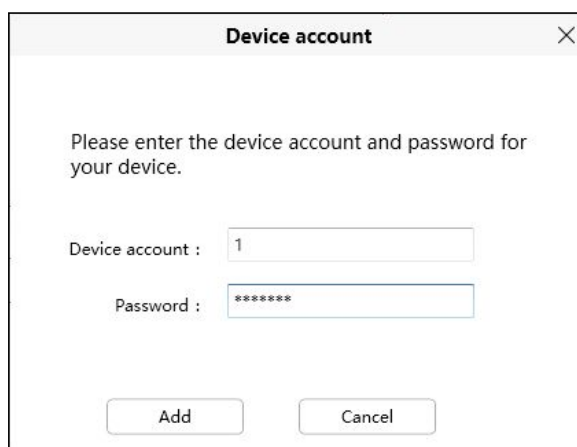

A dialog box titled "Device account" with a close button (X) in the top right corner. The text inside reads: "Please enter the device account and password for your device." Below this text are two input fields. The first is labeled "Device account :" and contains the number "1". The second is labeled "Password :" and contains seven asterisks "\*\*\*\*\*". At the bottom of the dialog are two buttons: "Add" and "Cancel".

**Step 5** Click **Add** button to finish adding.

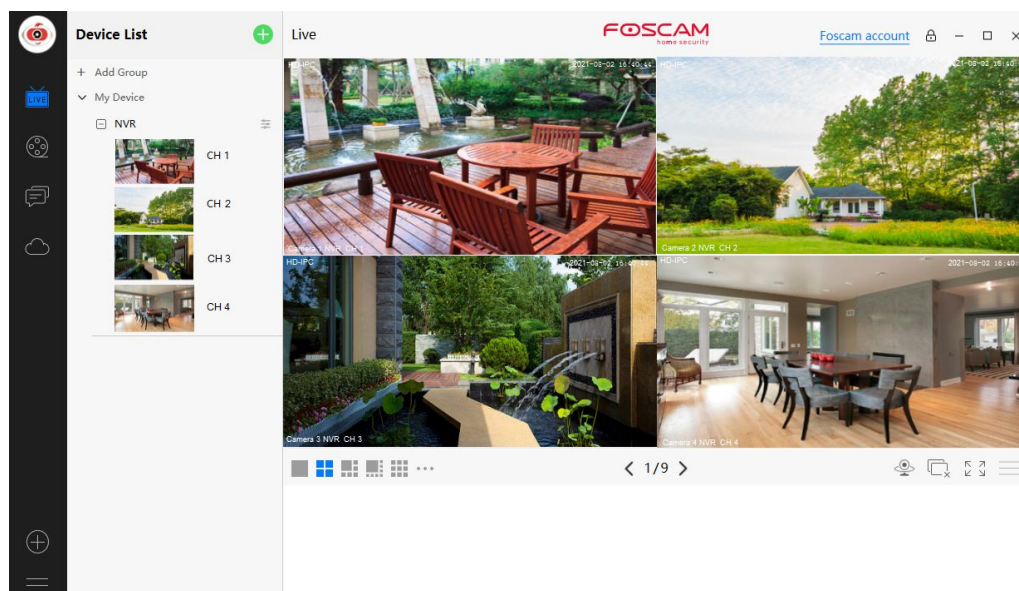

### 4.3.2 Manual add

You can add the NVR use manual add.

**Step 1** Click **Manual add** first.

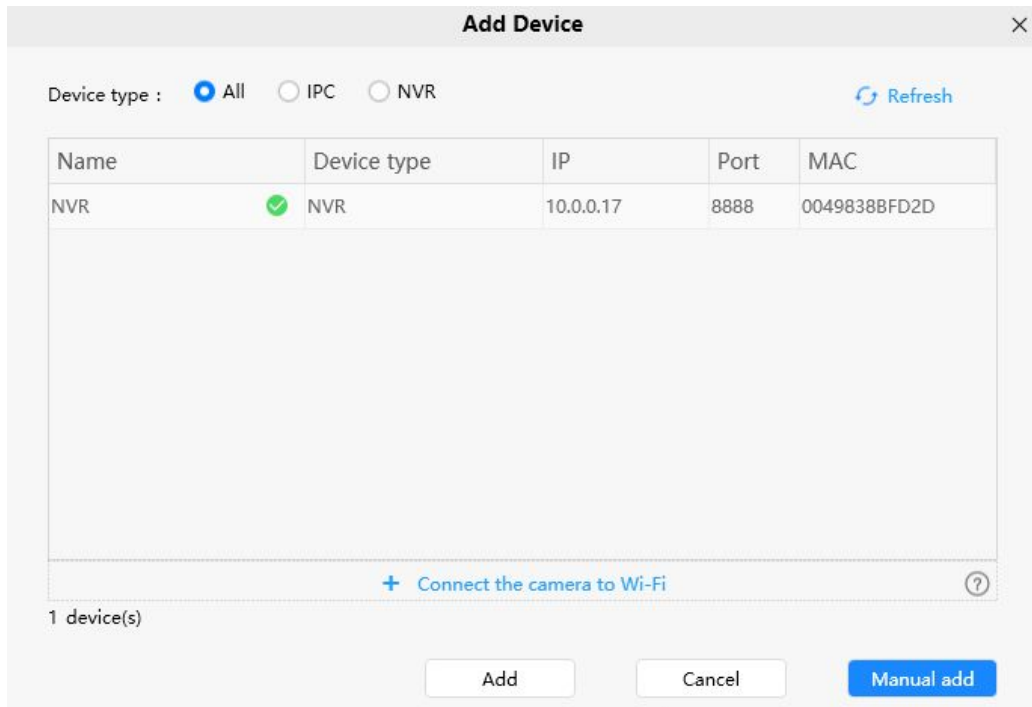

**Step 2** There are three ways to connect mode, you can choose any one.

- Check **UID** from Connection mode. Enter the UID of the device.

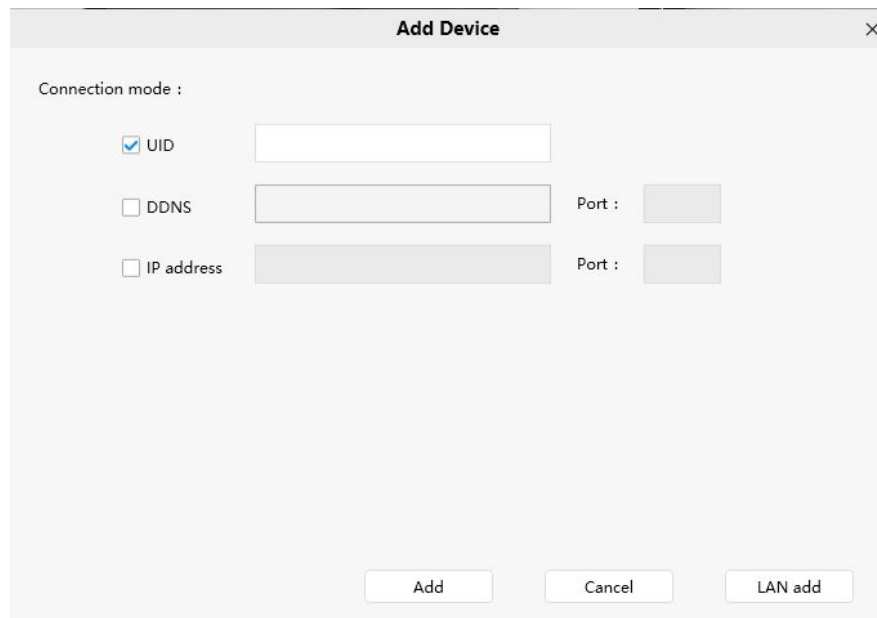

- Check **IP address** from the Connection Mode. Enter the IP and Port of the NVR. Select **NVR** from the Device types.



**Add Device** [X]

Connection mode :

UID [ ]

DDNS [ ] Port : [ ]

IP address [ ] Port : 88

Device type :

IPC

NVR

[ Add ] [ Cancel ] [ LAN add ]

**Step 3** Click **Add** button.

**Step 4** Enter **Device account** and **Password** of the NVR.

**Device account** [X]

Please enter the device account and password for your device.

Device account : [ ]

Password : [ ]

[ Add ] [ Cancel ]

**Step 5** Click **Add** button to finish adding device.

## 4.4 Surveillance Software GUI

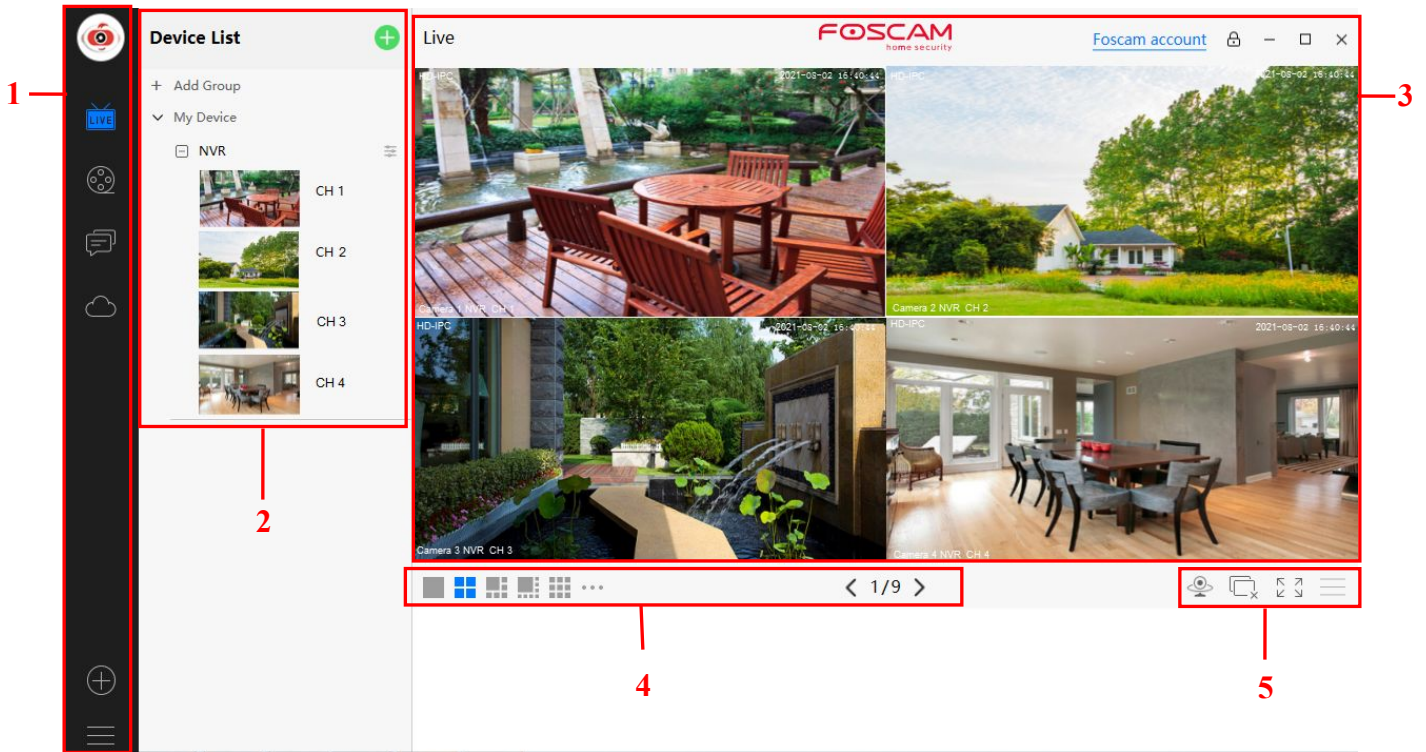

First time you login the software, the whole video window is gray, you need to connect the NVR and add NVR to it.

### Section1 Menu Bar



Path to surveillance window. Click this button enter to Device List and back to the surveillance

window.



Playback the video recording, you can choose Cloud Playback, SD Card Playback, NVR HDD Playback or Local Playback.



Login your Foscam cloud account to view alerts.



Login your Foscam cloud account.



Add Device, please refer chapter **4.3 Add Device** for the detail setting.



More, You can Setting Personal Account, Preference, My coupon, Log Query, Left

Bar and Switch Account.

## Section2 Left Bar

Add Group: Click the **+ Add Group** button, you can group the device list according to your needs.

**Left Bar of Live:** You can view the list of connected NVR.

Select the icon  on the right side of the NVR list to do the following.

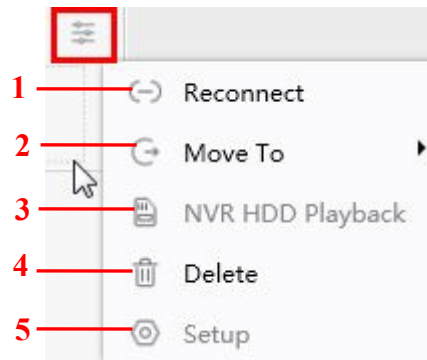

### 1-----Reconnect

Click Reconnect button and the device will reconnect.

### 2----- Move To

Click this button, you can move the device to your group list.

### 3-----NVR HDD Playback

If you have an HDD on your device, click this button to enter the NVR HDD Playback.

You can query the recording information of the hard disk by channel, record type, and date of record.

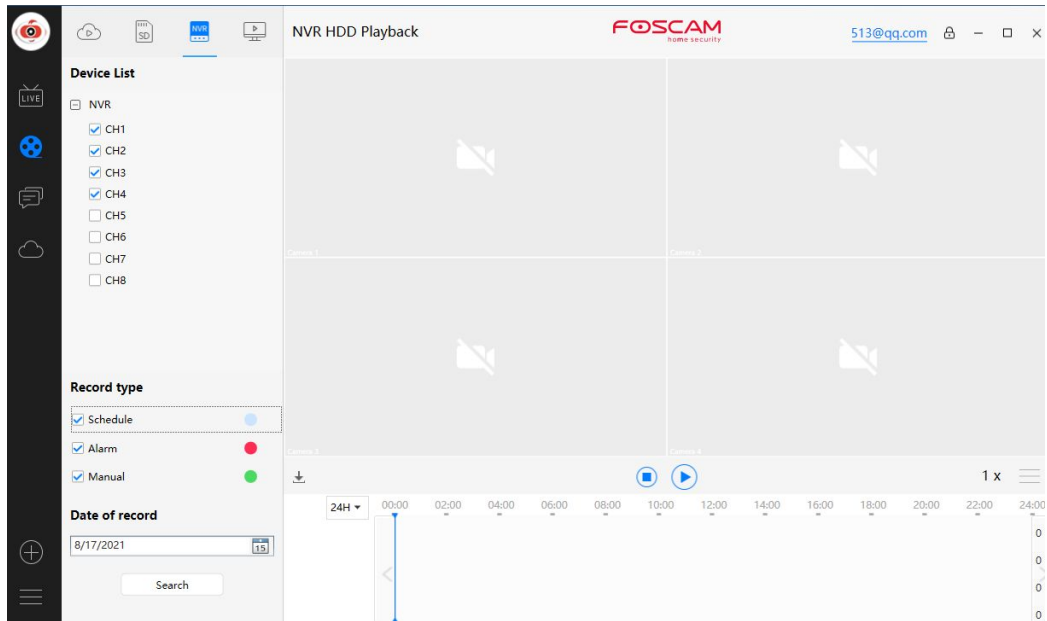

**4-----Delete**

Click the button, Delete the device.

**5----- Setup**

Click Setup button, goes to Device Settings Control Panel to make advanced NVR settings.

**Section3 Live Window**

When the mouse is placed on the video, the icon shown on the following figure appears.

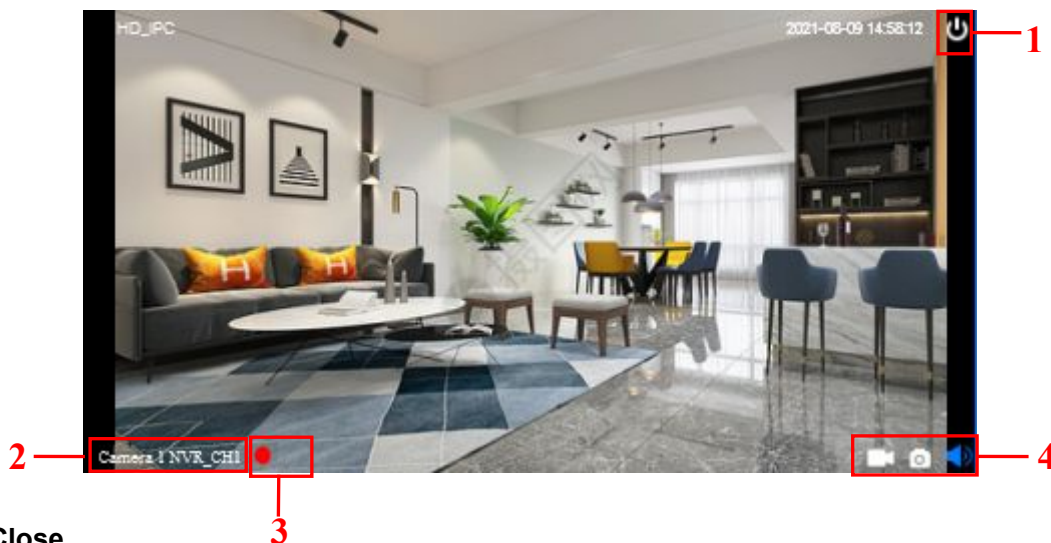

**1-----Close**

Click the icon to close this channel live window

**2-----Device Name**

Show view channel and camera name.

**3-----Recording and Alarm status**

 This icon will turn to red, it indicates that the camera is recording

**4----- Record / Snap Shot / Sound**

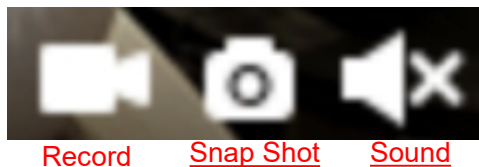

**Record** ----- Click it and do manually recording. When recording, icon 1 will turn to blue. Click it again and stop recording. The recording files will be stored to C:\VMS\_RECORD automatically.

**Snap Shot** ----- Click it to make snapshot. After snapshot, the button banner will prompt **Captured Successfully**. And you can find the picture on default path C:\VMS\_CAPTURE.

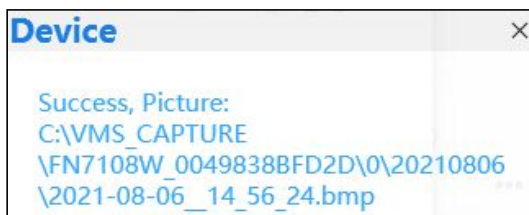

**Sound** ----- Click the icon then you will hear sound captured by the camera's built-in microphone. You may need to plug in earphones or enable the computer speakers to hear from the camera's microphone. Make sure the camera supports audio. Click again and stop audio.

**Section4 The number of split-screen**



Click this button to select the number of split-screen on one page.



The client can monitor many cameras at one page, here you can choose the display number. The maximum number is 16.

**Section5 Live Cruise / Close All / Full Screen / Hide Bar**



 **Live Cruise** ----- Click this button to Live Cruise, you can click  button to add a loop page for live Cruise or click  button to reduce the loop page for live Cruise.

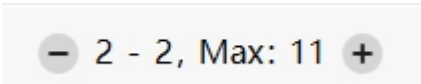

**Close All** ----- Click this button to close all the cameras



**Full Screen** ----- Click this button to enter full screen, then click to exit full screen.



**Hide Bar** ----- Click this button, Hide and show Pan / Tilt control Bar

## 4.5 Setup

Select the icon  on the right side of the NVR list to do the following. Click **Setup** button, goes to **Device Settings** control panel to make advanced NVR settings.

### 4.5.1 Basic

#### Device Information

You can modify the device name. You can also see the basic information of the NVR.

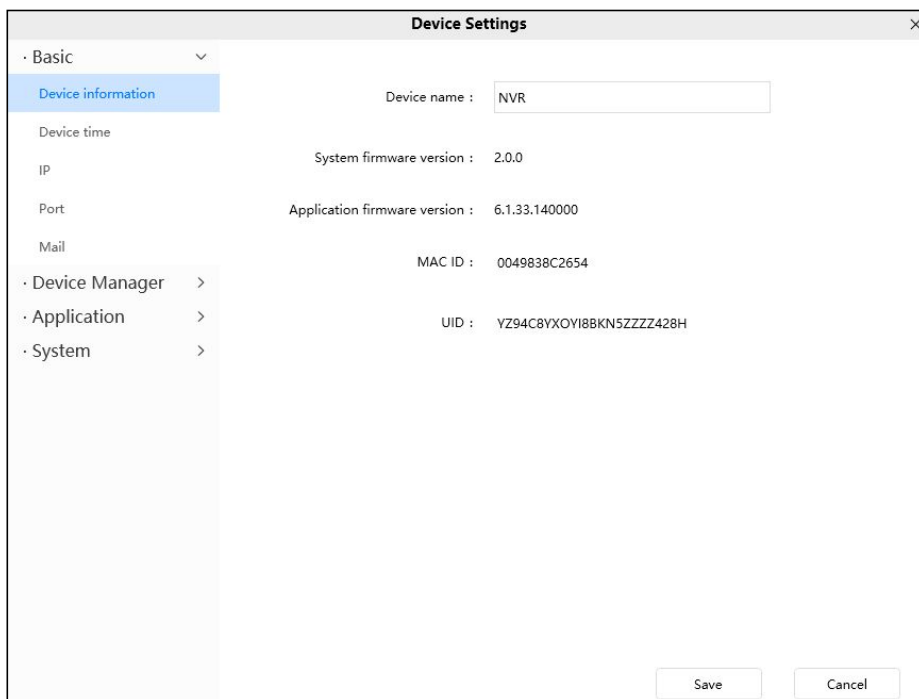

**Device name:** The Device Name is a unique name that you can give to your device to help you identify it. You can define a name for your NVR here such as NVR1. Click Save to save your changes. The alias name cannot contain special characters.

**System firmware version:** Display the system firmware version of your NVR.

**Application firmware version:** Display the application firmware version of your NVR.

**MAC ID:** Display the MAC address of your NVR. For example Device ID is 0049838BFD2D, the same MAC ID sticker is found at the bottom of the NVR.

## Device time

This section allows you to configure the settings of the internal system clock for your camera. You can set the time zone, device time, date format.

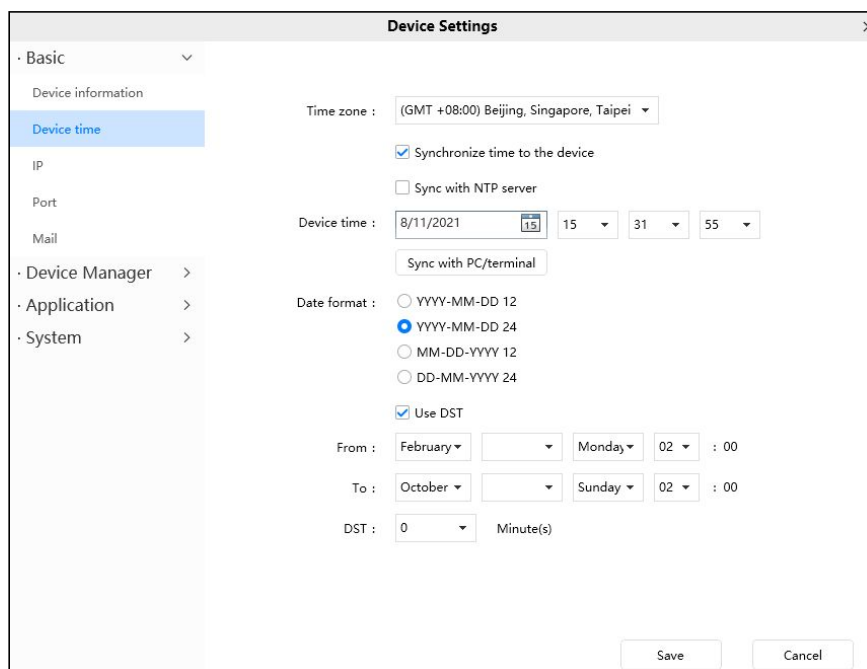

**Time zone:** Select the time zone for your region from the drop down menu.

**Synchronize time to the device:** After checking the **Synchronize time to the device** checkbox, you can set the device time, or click the **Sync with PC/terminal** button to synchronize the PC/terminal time to your device.

**Sync with NTP server:** Network Time Protocol will synchronize your device with an Internet time server. Choose the one that is closest to your device.

**Use DST:** Select the **use DST** (Daylight Saving Time, to set the clock ahead of the real-time), then set the start time and end time of the DST, select the daylight saving time from the drop-down menu at last.

Click **Save** button and submit your settings.

## IP

If you want to set a static IP for the device, please go to **IP** page. Keep the device in the same subnet of your router or computer.

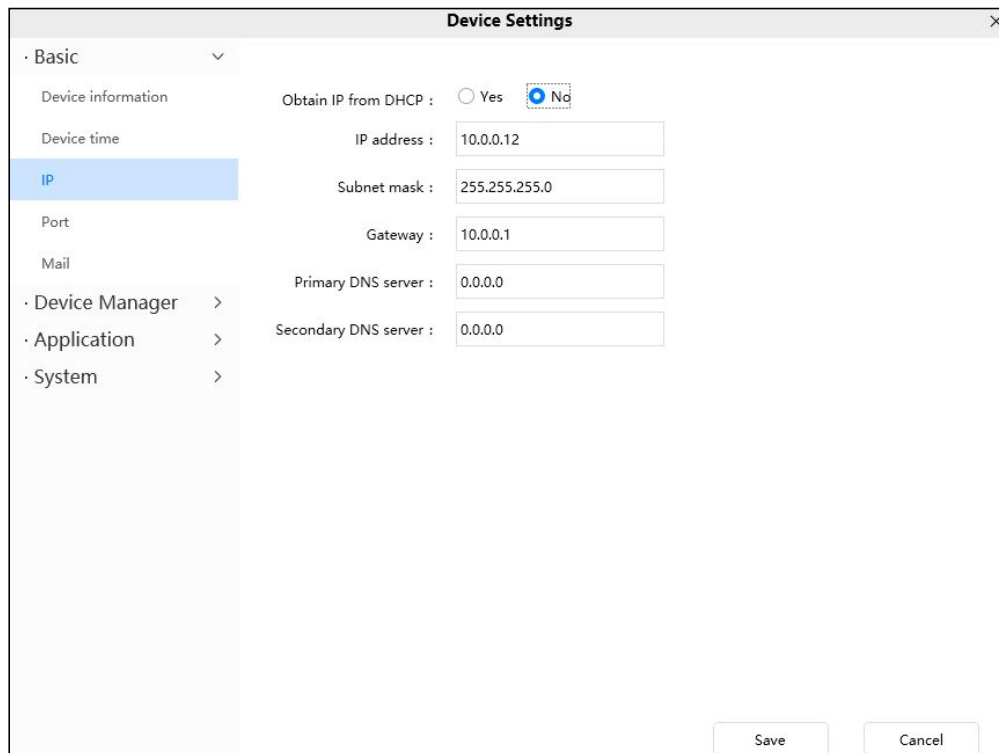

It is recommended that you use the subnet mask, gateway and DNS server from your locally attached PC. If you don't know the subnet mask, gateway and DNS server, you can check your computer's local area connection as follows:

**Settings--Network & internet--Ethernet --Edit--Edit IP Settings.**



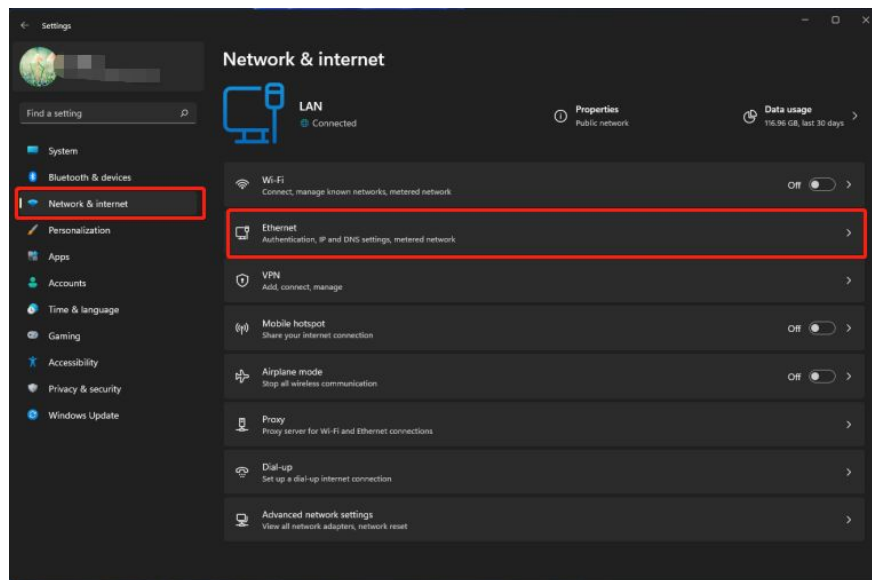
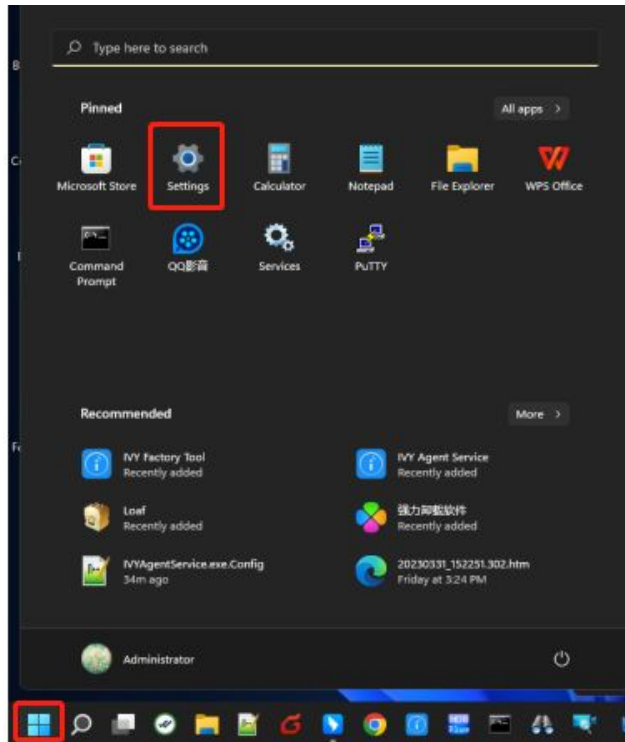

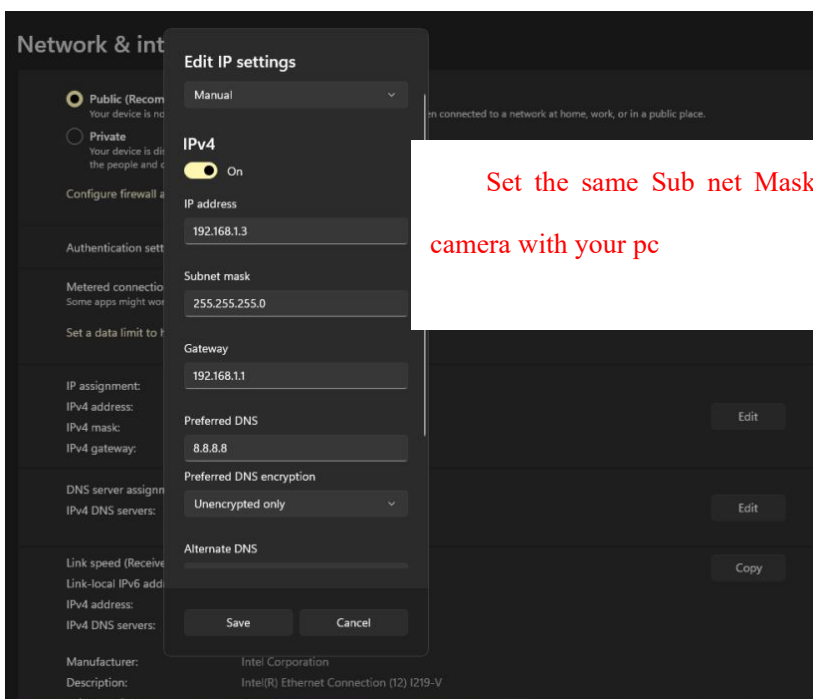
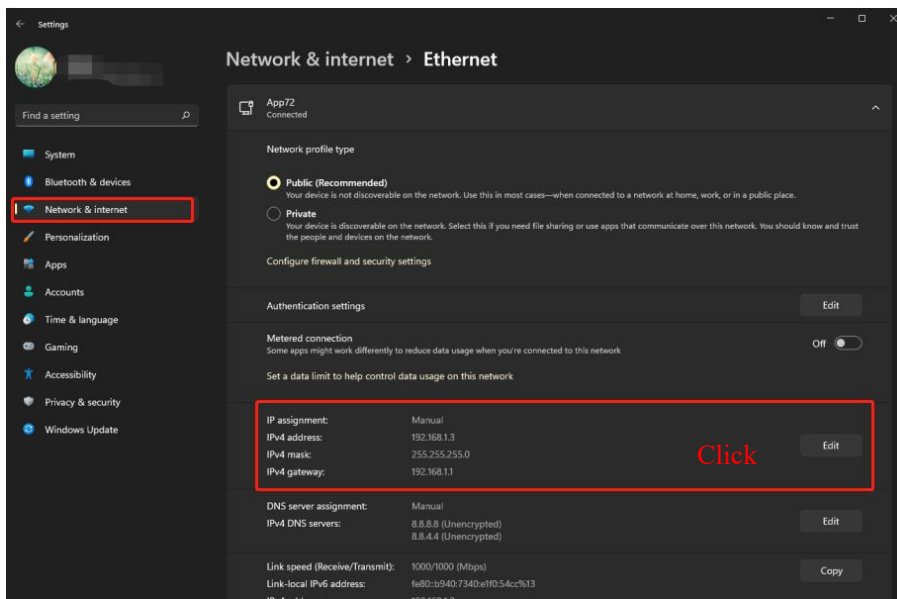

If you don't know the DNS server, you can use the same settings as the Default Gateway.

## Port

This device supports HTTP Port / HTTPS Port. HTTP Port is used to access the device remotely.

**HTTP port:** By default, the HTTP is set to 88. Also, they can be assigned with another port number between 1 and 65535. But make sure they can not be conflict with other existing ports.

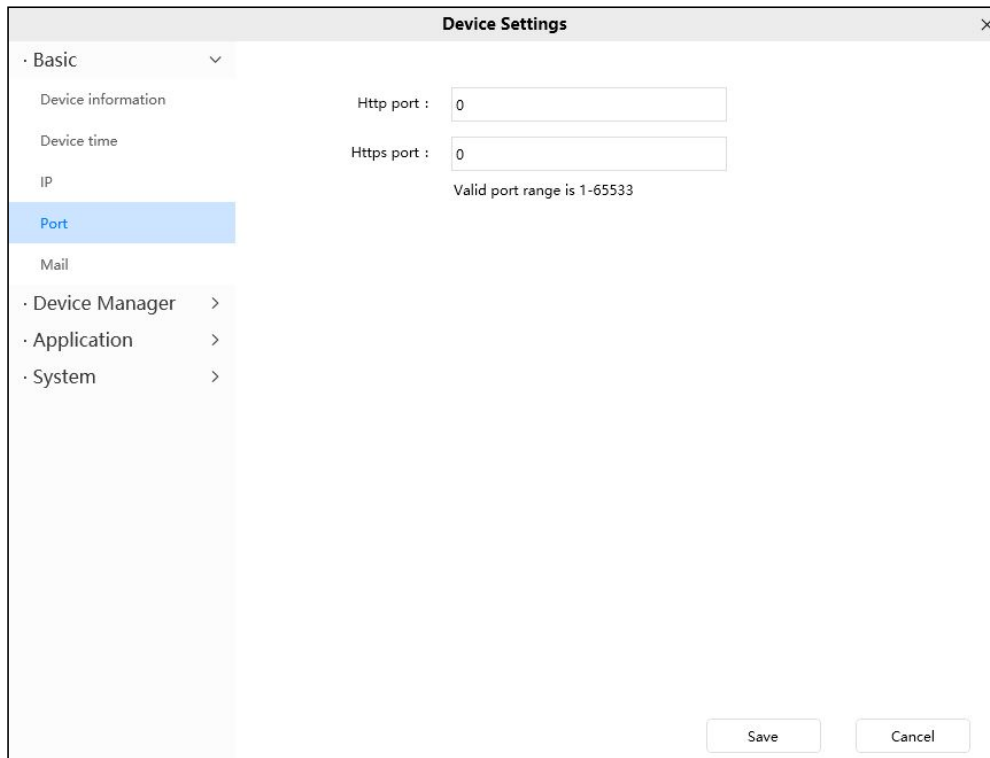

## Mail

If you want the NVR to send emails when motion has been detected, here mail will need to be configured.

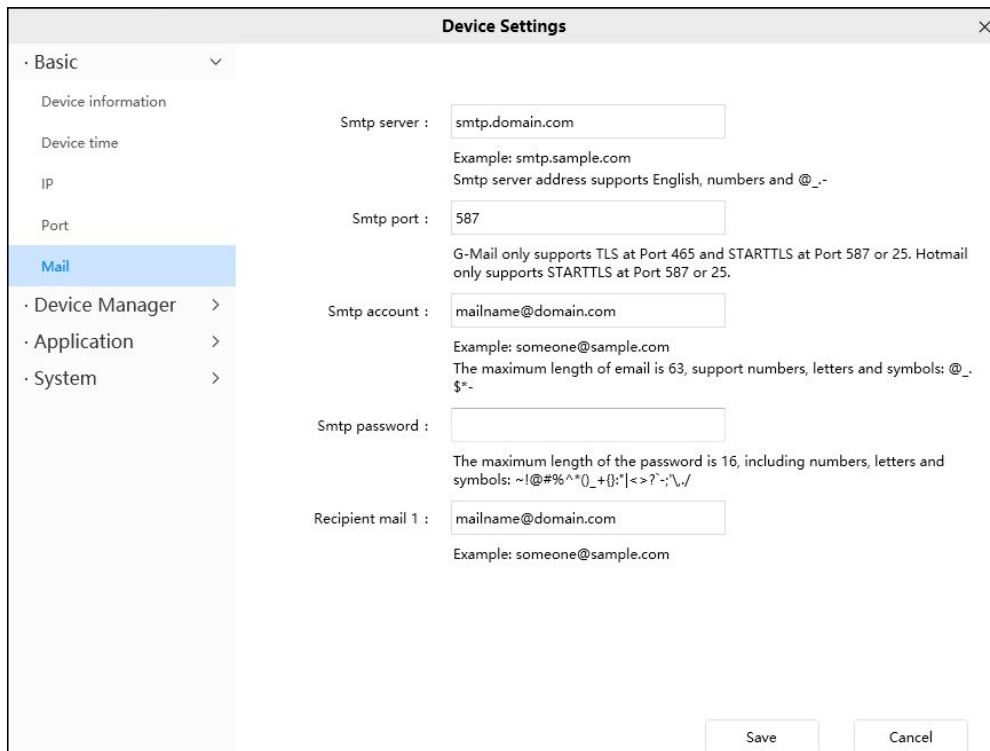

**1----- SMTP server/ Port**      Enter SMTP server for sender. SMTP port is usually set as 25.

Some SMTP servers have their own port, such as 587 or 465, and Transport Layer Security usually is None. If you use Gmail, Transport Layer Security must be set to TLS or STARTTLS and SMTP Port must be set to 465 or 25 or 587, which port you choose should be decided by which Transport Layer Security you select.

**2----- SMTP account/ password** ID account and password of the sender email address

**3----- Recipient mail 1** Mailbox for receiver need not support SMTP, you can set 4 receivers.

**4----- Save** Click Save to take effect.

## 4.5.2 Device Manager

### IP camera setup

You can add the camera for the NVR device on this page.

Select the channel in the channel list box, enter the device information, click the add button, and the system will prompt for success.

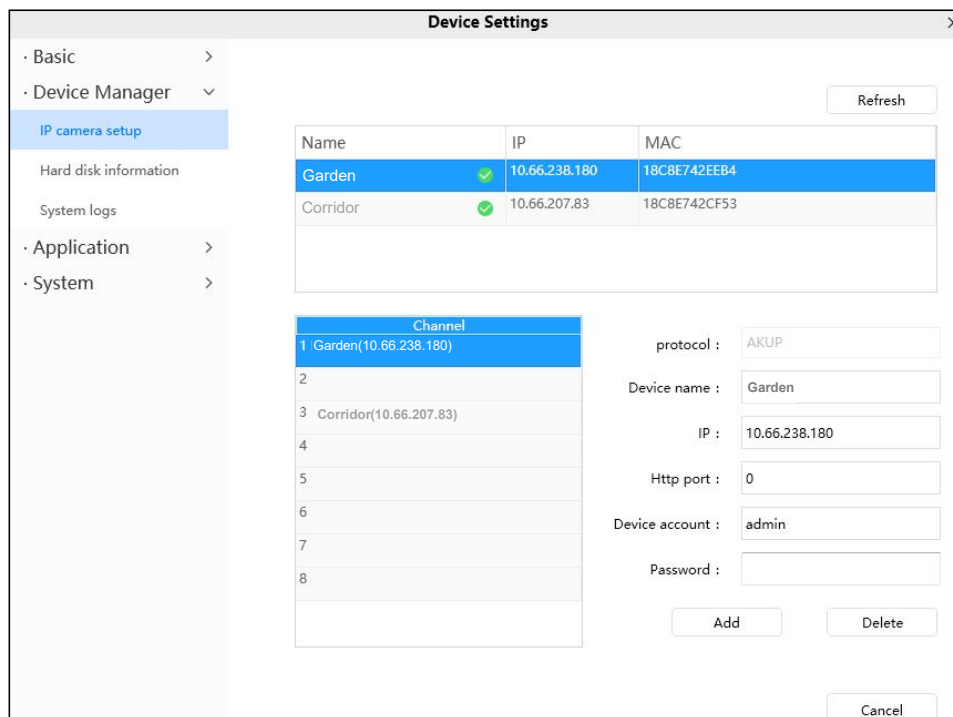

**Device account/Password:** The Device account/Password is the user name and password you set when you first logged in to the NVR system using the monitor.

## Hard disk information

You can view the hard disk information of NVR.

Click the **Format local disk** button to clear the hard disk information of NVR.

If your hard disk is full, you can check whether to Stop recording or Cover earliest record.

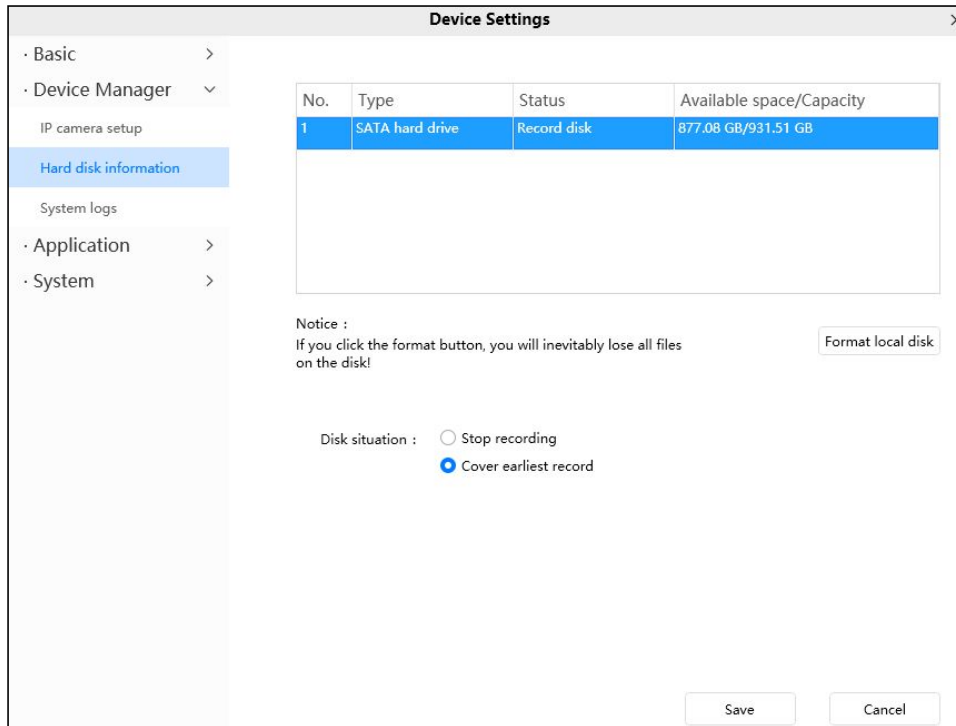

After the modification is completed, click **Save** button to take effect.

## System logs

You can query the Alarm logs, Operation logs and System log of the NVR.

Device Settings

Channel : NVR

Log type :  All logs  Alarm logs  Operation logs  System logs

Date : 8/11/2021

Start time : 00 : 00 : 00

End time : 23 : 59 : 59

Search

No.	Channel	Time	User	IP	Log
1	CH1	2021-08-11 16:30:16	system	0.0.0.0	Video loss
2	CH2	2021-08-11 16:30:16	system	0.0.0.0	Video loss
3	CH3	2021-08-11 16:30:16	system	0.0.0.0	Video loss
4	NVR	2021-08-11 16:30:17	system	0.0.0.0	System restart
5	NVR	2021-08-11 16:41:20	system	0.0.0.0	Parameter settings
6	CH1	2021-08-11 22:21:08	system	0.0.0.0	Video loss
7	CH2	2021-08-11 22:21:08	system	0.0.0.0	Video loss
8	CH3	2021-08-11 22:21:08	system	0.0.0.0	Video loss
9	NVR	2021-08-11 22:21:08	system	0.0.0.0	System restart
10	NVR	2021-08-11 22:42:12	system	0.0.0.0	Parameter settings

Total 1 Pages

< 1 > 1 Go

Cancel

Click the page number and go to the corresponding page to see more logs

Full in one page number, click GO button and go to the corresponding page.

## 4.5.3 Application

### Motion detection

The NVR supports **Motion Detection Alarm**, when the motion has been detected, it will send emails.

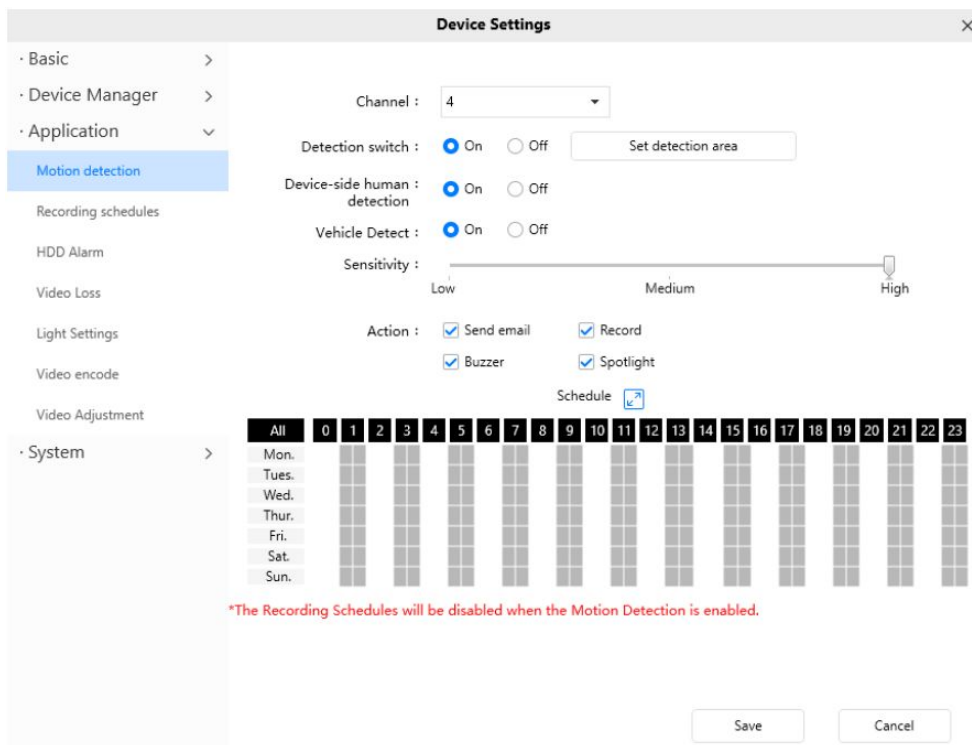

To enable motion detection, follow the steps below:

**1 Channel**---- Select the channel that needs motion detection.

**2 Detection switch**---- Whether to enable motion detection

**3 Set detection area**----You can set the alarm area.

**4 Device-side human detection / Human detection**---- Whether to turn on detection.

**5 Vehicle Detection** ---- Whether to turn on detection.(Supported only for some models, such as V5EP V8EP T5EP T8EP V5P)

**6 Sensitivity**---- It supports three modes: Low, Middle and High. The higher the sensitivity, the camera will be more easily alarmed. Select one motion sensitivity.

**7 Select the Action**

There are some alarm indicators:

- Send E-mail

If you want to receive alarm emails when motion is detected, you must select Send E-mail and set Mail Settings first. Make sure you have set E-mail in “Device Setting -> Basic -> Mail” interface.

- Recording

If you select this checkbox, when the motion has been detected, the NVR will recording and store in HDD.

- Buzzer

If you select this checkbox, when the motion has been detected, the NVR will alert the buzzer.

### 8 Alarm Schedule

- Alarm anytime when motion is detected.

Click the black button up the MON, you will see all time range turn red. When something moving in the detection area at anytime, the NVR will alarm.

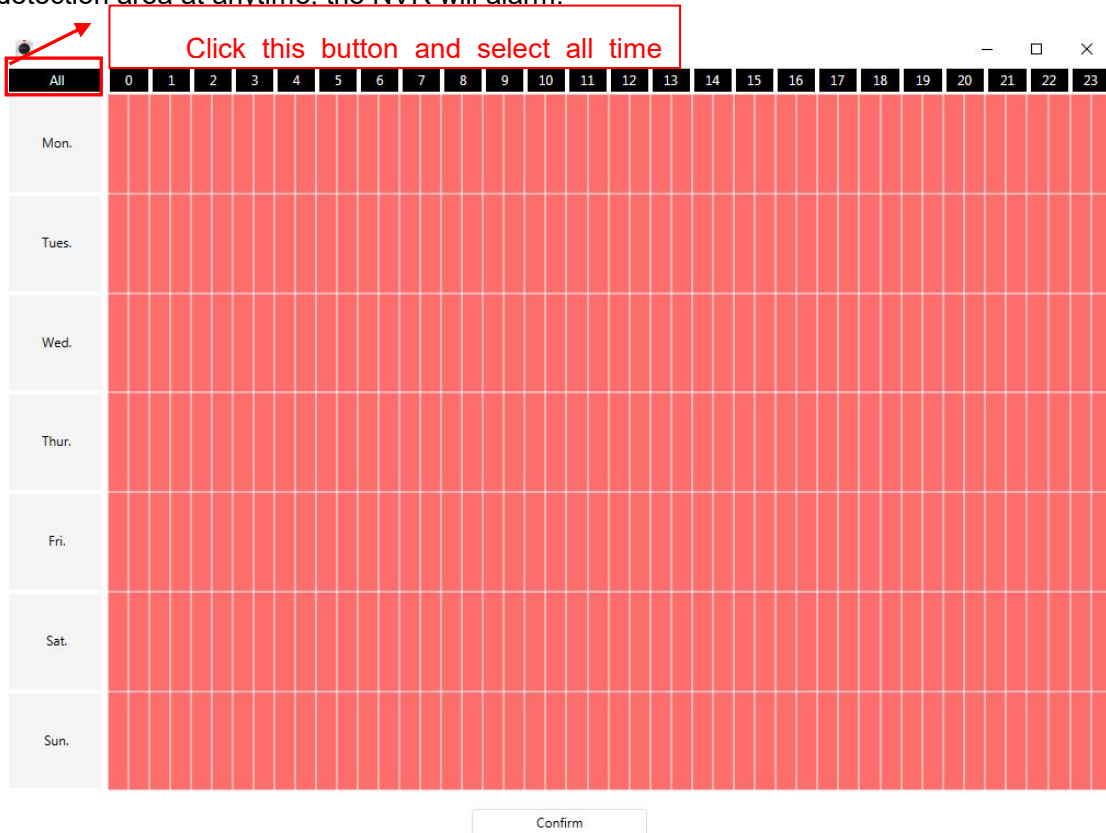

- Specify an alarm schedule

Click the week day words, the corresponding column will be selected. For example, click TUE, the all column of TUE turns to red, that means during Tuesday whole day, when something moving in the detection area, the NVR will alarm.



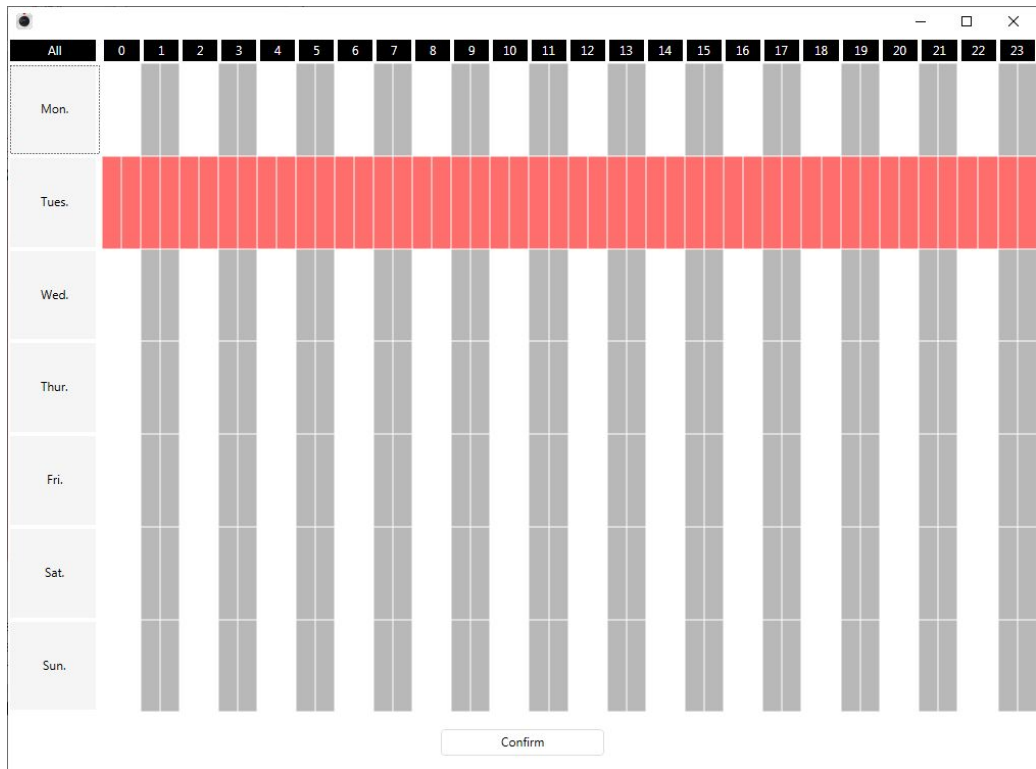

- Press the left mouse and drag it on the time boxes, you can select the serial area.

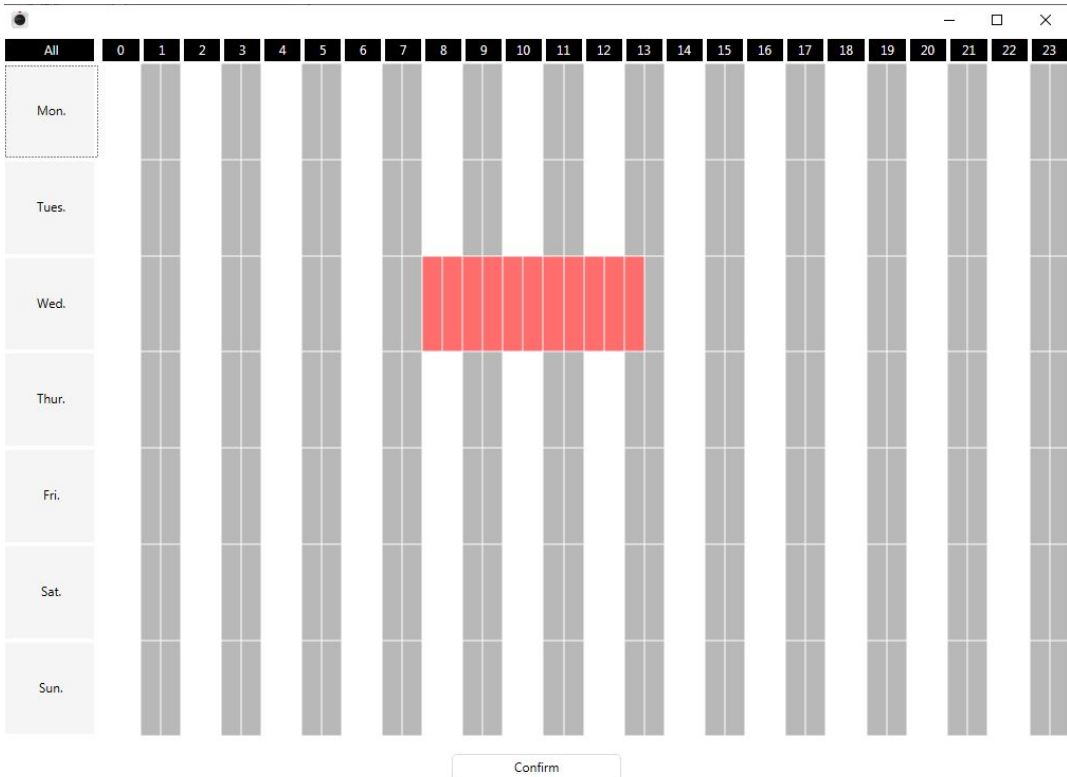

**9 Click Save button** to take effect. When the motion is detected during the detection time in the detection area, the NVR will alarm and adopt the corresponding alarm indicators.



**Note**

You must set the detection area and detection schedule, or else there is no alarm anywhere and anytime.

**Recording schedules**

On the page you can configure the schedule record. Schedule Recording only supports HDD.

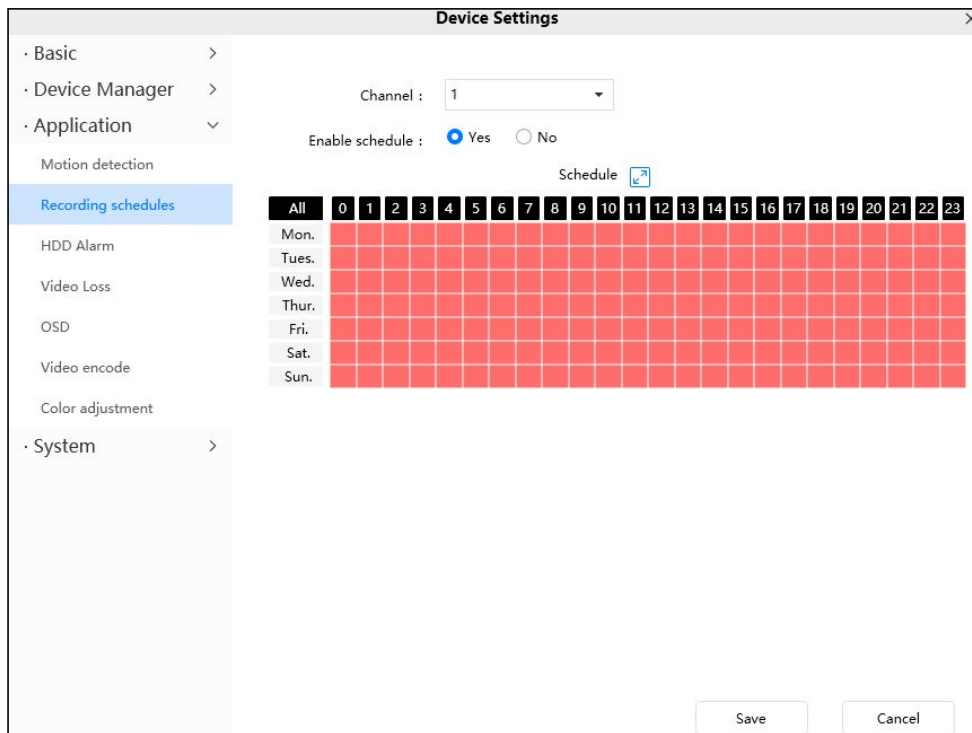

Select the recording channel. Check the **Enable schedule** checkbox, then you can set the schedule for recording.

Click **Save** button to take effect.

**HDD Alarm**

When the hard disk is error, lose or full, you can set the NVR alarm.

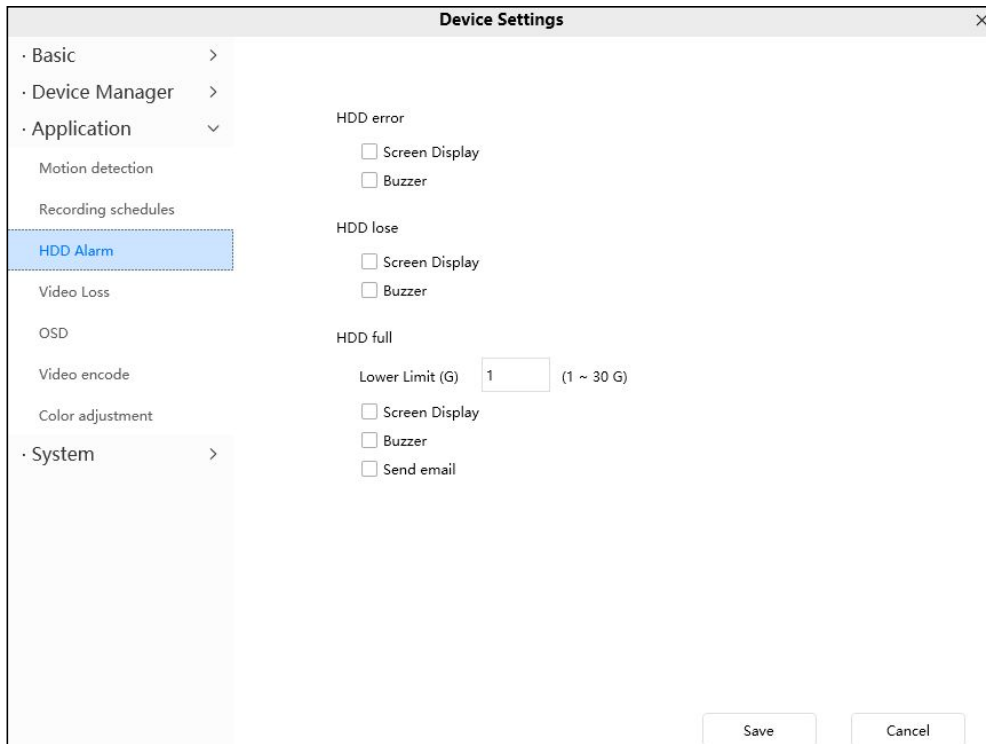

## Video Loss

When the video is lost, you can set an alarm message.

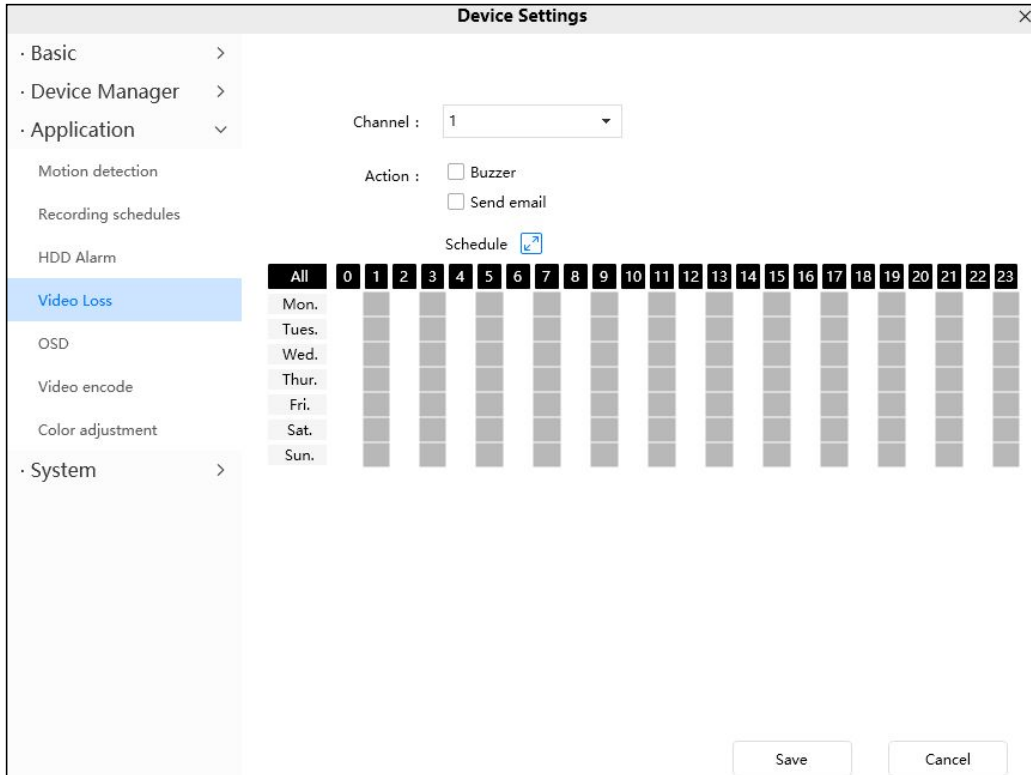

To enable motion detection, follow the steps below:

**1 Channel**---- Select the channel.

## 2 Action

- Send E-mail

If you want to receive alarm emails when video loss, you must select Send E-mail and set Mail Settings first. Make sure you have set E-mail in “Device Setting -> Basic -> Mail” interface.

- Buzzer

If you select this checkbox, when the video has been loss, the NVR will alert the buzzer.

## OSD

This page is used to add time and device name on the video.

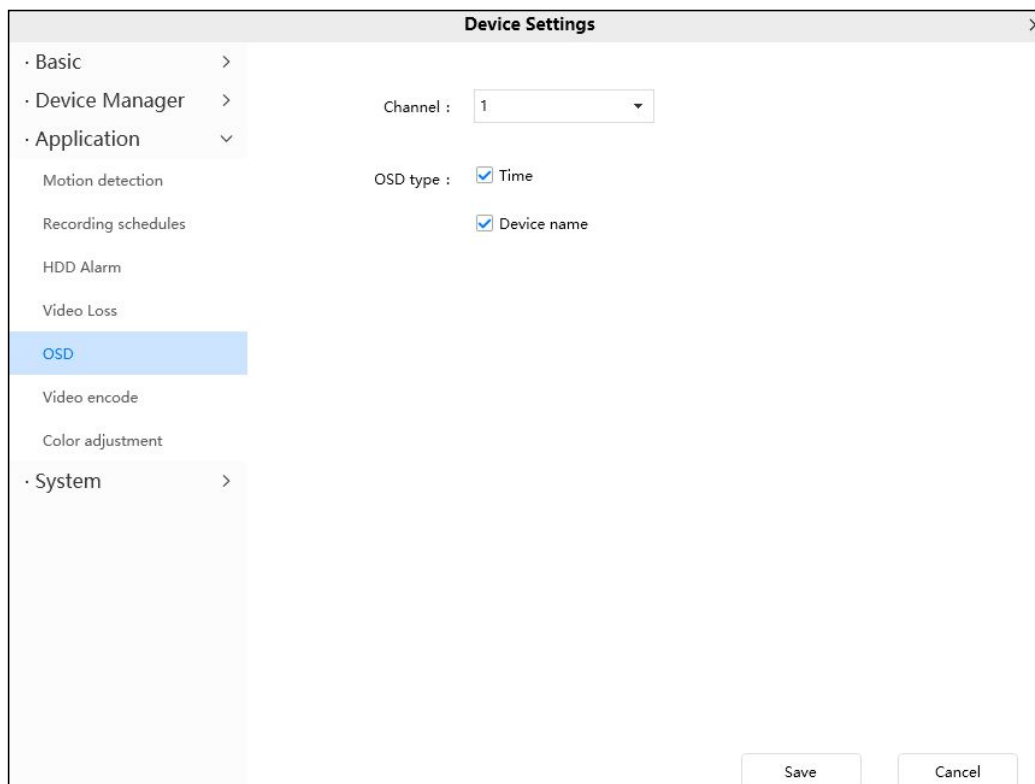

## Video encode

This is main/sub stream video settings.

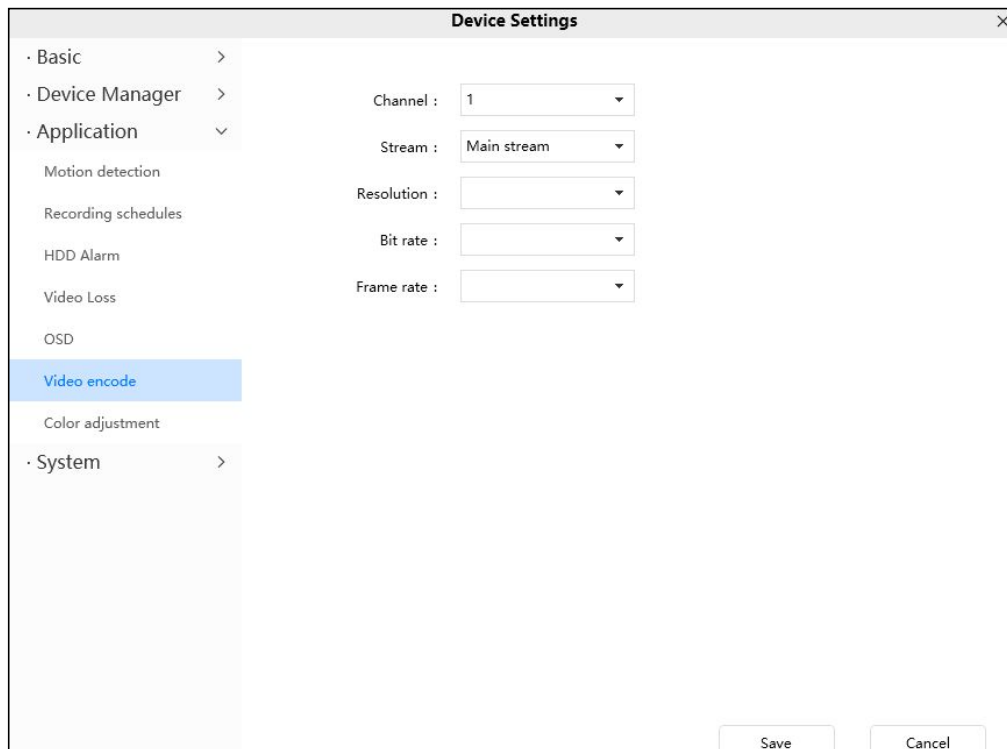

**Channel:** Select the channel.

**Stream:** There are two types to identify different streams you have set.

**Resolution:** The camera supports multiple types in the channel, For example: 2K,3M,1080P, 720P, VGA. The higher the resolution is, the clearer video will become. But the code flux will become larger too, and it will take up more bandwidth. (Different models support different specific types. )

**Bit Rate:** Generally speaking, the larger the bit rate is, the clearer video will become. But the bit rate configuration should combine well with the network bandwidth. When the bandwidth is very narrow, and bit rate is large, that will lead to video can not play well.

**Frame Rate:** Note that a larger frame size takes up more bandwidth. When the video format is 50Hz, the maximum frame rate is 25 fps. When the video format is 60Hz, the maximum frame rate is 30 fps. You should lower frame rate when the bandwidth is limited. Normally, when the frame rate above 15, you can achieve fluently video.

Click **Save** button to take effect.

## Color adjustment

You can adjust the settings to your liking.

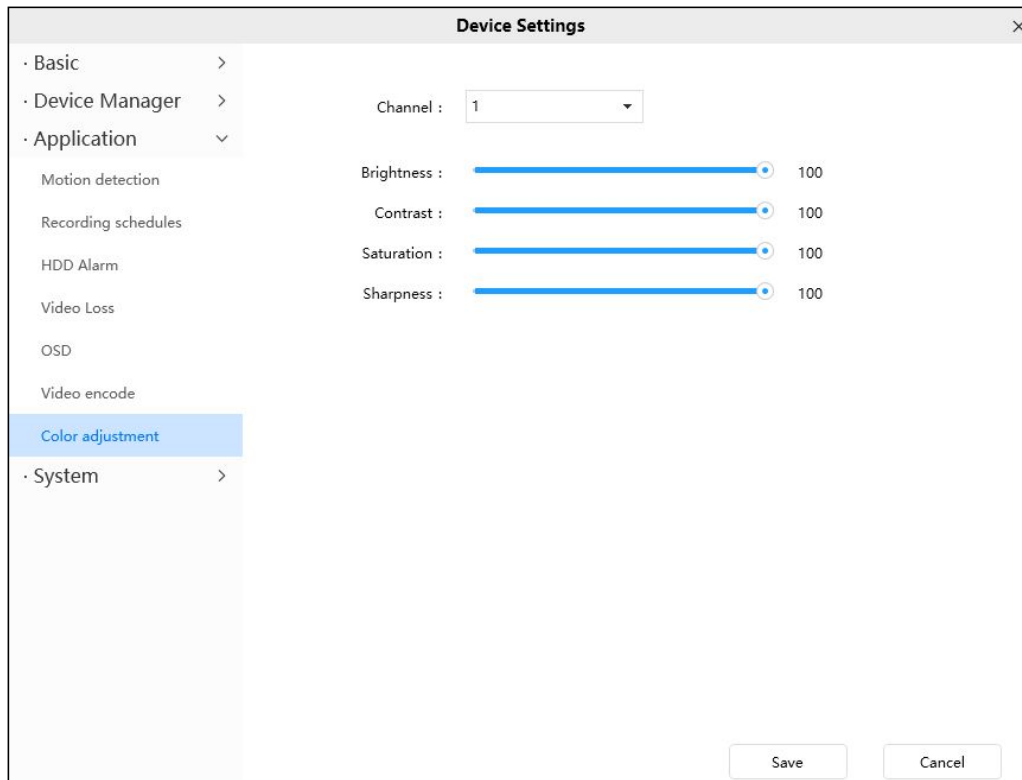

## 4.5.4 System

### System upgrade

Click **Download the Latest Firmware**, you will see the following screen. And click **Save** to save the firmware on your computer locally.

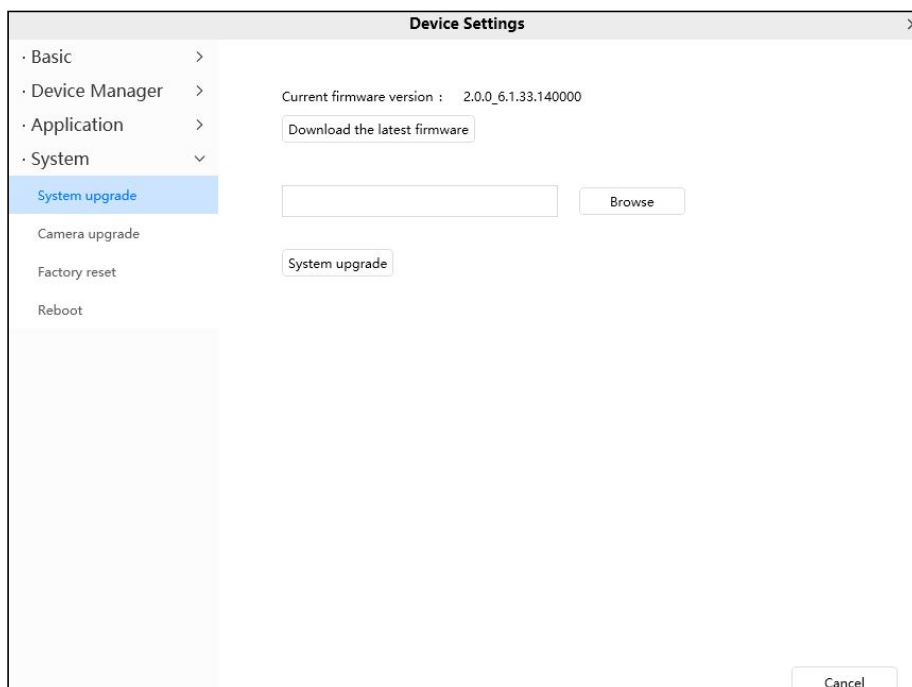

Your current firmware version will be displayed on your screen.

Click **Browse**, choose the correct bin file and then click **System upgrade**.

Don't shut down the power during upgrade. After upgrading, you can see the upgrade result.

## Camera upgrade

Click **Download the Latest Firmware**, you will see the following screen. And click **Save** to save the firmware on your computer locally.

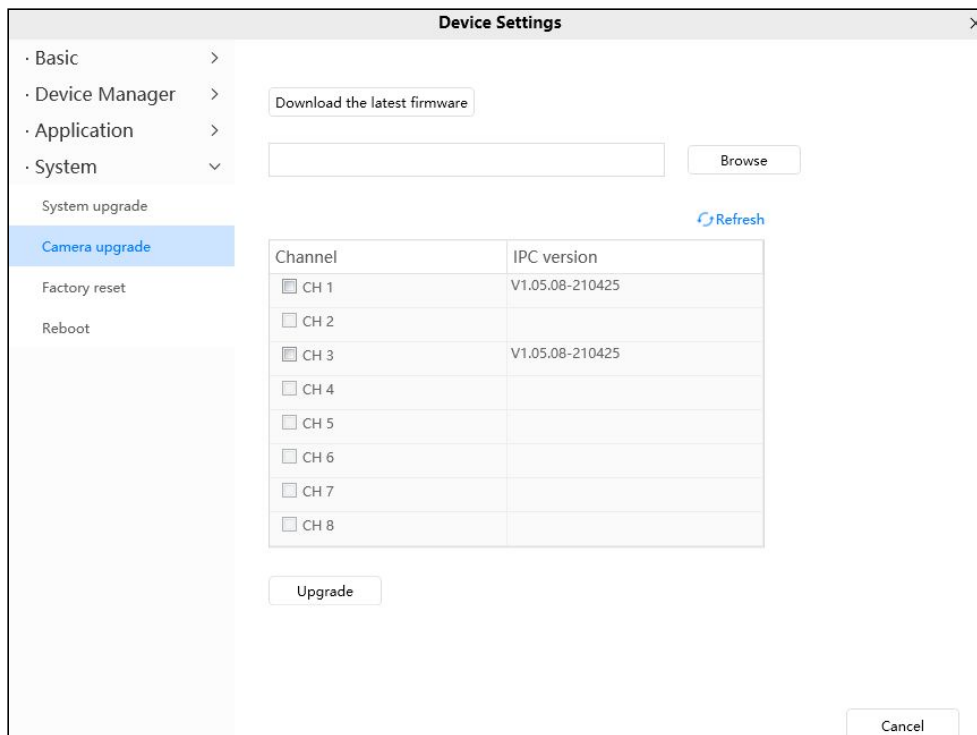

Your IPC current firmware version will be displayed on your screen.

Click **Browse**, choose the correct bin file and then click **upgrade**.

Don't shut down the power during upgrade. After upgrading, you can see the upgrade result.

## Factory reset

Click **Factory Reset** button and all parameters will return to factory settings if selected.

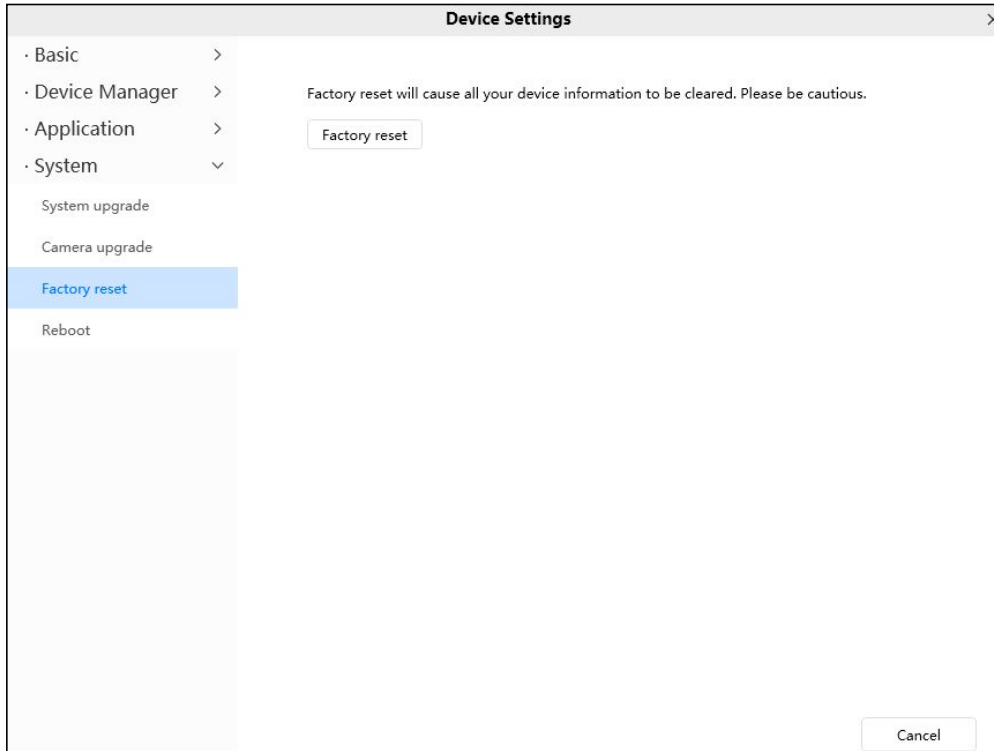

## Reboot

Click **Reboot device** to reboot the NVR. This is similar to unplugging the power to the NVR.

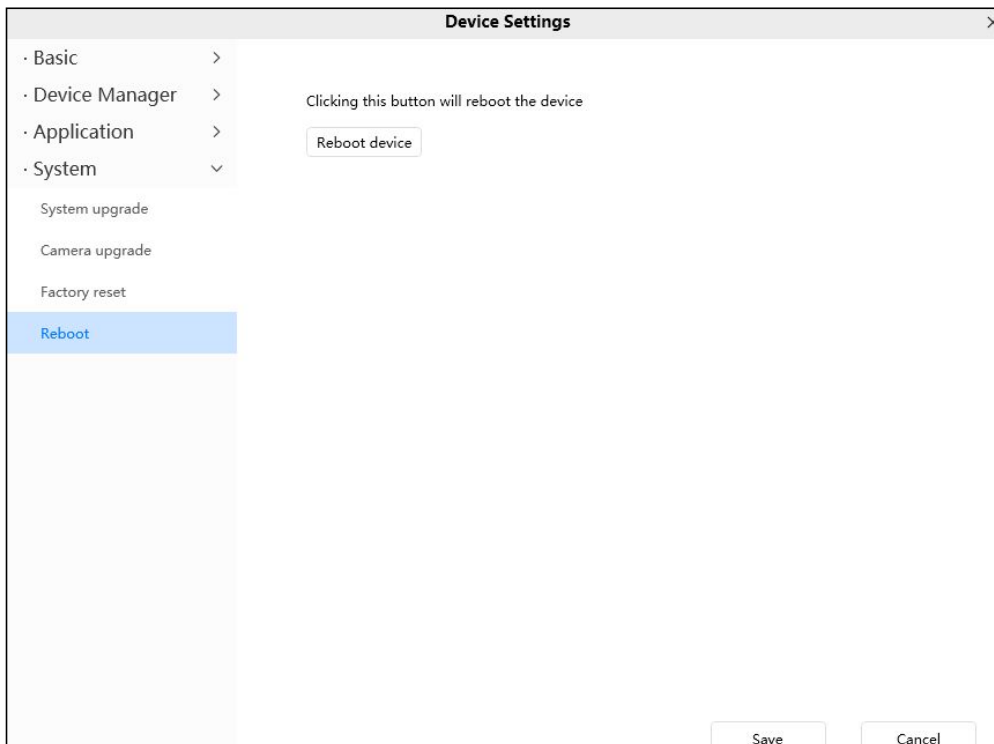



# 5 Appendix

---

## 5.1 HDD Capacity Calculation

This chapter describes how to determine the size of the HDD you need when you install the NVR for the first time.

The NVR adopts the MPEG4/H.264 compression technology and its dynamic range is large.

Therefore, the capacity of the HDD depends on the estimated size of files generated in each channel every hour according to code streams.

Computational formula of HDD Capacity:

Whole HDD Capacity(M)= number of the channels \* time in need (hour) \* spent of HDD Capacity per hour (MB/hour)

The meanings of parameters are as follows:

- Number of the channels: Number of channels where you need to enable recording.
- Time in need (hour): Time you need to record.
- Spent of HDD Capacity per hour

$$\text{Spent of HDD Capacity per hour(M/hour)} = \frac{\text{BitRate}}{8\text{bit}} * 3600(\text{sec ond})$$

You can obtain the **Bit Rate** by using the following methods:

-In the GUI interface, choose **Menu > Settings > Video** , view the value of the **Bit Rate**.

-In the Web interface, choose **Parameter Configuration > Local settings > Encoding Scheme**, view the value of the **Bit Rate**.

[Example]

If you select 4M for the bit rate and select four channels for recording and one week of recording is needed, you can calculate the HDD capacity by using the following formula:

Recording time(hour) =7days\*24 hours=168 hour

$$\text{Spent of HDD Capacity per hour(M/hour)} = \frac{4\text{Mbit}}{8\text{bit}} * 3600 = 1800\text{M/hour}$$

Whole HDD Capacity(M)=4\*168(hour)\*1800 (M/hour) =1209600M,

$$1209600M = \frac{1209600M}{1024} = 1181.25G$$

According to the preceding calculation result, you are advised to buy a HDD of 1.5 TB or above.

## 5.2 Specifications

ITEMS		FN9108HE
<b>Video Input</b>	<b>IP Video Input</b>	8 Channels QHD IP camera input
<b>Video Output</b>	<b>HDMI Output</b>	1×HDMI
	<b>VGA Output</b>	1×VGA
	<b>Display Resolution</b>	3840x2160, 2560x1440,1920x1080,1440x900,1280x1024,1280x800,1280x720,1024x768
<b>Recording</b>	<b>Recording Resolution</b>	Up to 5MP per channel ( 8ch@5MP )
	<b>Record Mode</b>	Time Scheduled / Motion Detect
	<b>Compression Format</b>	H.264/H.264+
<b>Playback</b>	<b>Synchronous Playback</b>	8 channels synchronous video playback
	<b>Playback Mode</b>	Pause / Stop / Slow / Fast/ Frame Play
<b>Network</b>	<b>Ethernet</b>	One 10/100Mbps RJ45 port
	<b>POE Standard</b>	IEEE 802.3at/af
	<b>Network Protocol</b>	IP, TCP, UDP, SMTP, DHCP, RTSP
<b>HDD</b>	<b>Capacity</b>	Up to 16TB
<b>External Interface</b>	<b>Network Interface</b>	1× 10/100 Mbps RJ45 port
	<b>USB Interface</b>	2× USB2.0 interface for mouse and external storage
	<b>Button</b>	1× Power on/off button,1× Reset button
<b>System</b>	<b>Operating System</b>	Microsoft Windows (Foscam VMS), MacOS (Foscam VMS),

<b>Requirements</b>		Android (Foscam app),iOS (Foscam app)
	<b>Smart Phone</b>	iOS,Android,3G/4G/5G Smartphones
<b>Language</b>	<b>Language</b>	17 languages
<b>Physical and Environmental</b>	<b>Power Supply</b>	DC 48V/2A
	<b>Dimension(LxWxH)</b>	255mm*238mm*50mm
	<b>Net Weight (g)</b>	880g
	<b>Operating Temperature</b>	0°C ~ 55°C (32°F ~ 131°F)
	<b>Operating Humidity</b>	20% ~ 85% non-condensing
	<b>Storage Temperature</b>	-20°C ~ 60°C (-4°F ~ 140°F)
	<b>Storage Humidity</b>	0% ~ 90% non-condensing

<b>ITEMS</b>		<b>FN9108H</b>
<b>Video Input</b>	<b>IP Video Input</b>	8 Channels QHD IP camera input
<b>Video Output</b>	<b>HDMI Output</b>	1×HDMI
	<b>VGA Output</b>	1×VGA
	<b>Display Resolution</b>	3840x2160, 2560x1440,1920x1080,1440x900,1280x1024,1280x800,1280x720,1024x768
<b>Recording</b>	<b>Recording Resolution</b>	Up to 5MP per channel ( 8ch@5MP )
	<b>Record Mode</b>	Time Scheduled / Motion Detect
	<b>Compression Format</b>	H.264/H.264+
<b>Playback</b>	<b>Synchronous Playback</b>	8 channels synchronous video playback
	<b>Playback Mode</b>	Pause / Stop / Slow / Fast/ Frame Play
<b>Network</b>	<b>Ethernet</b>	One 10/100Mbps RJ45 port
	<b>Network Protocol</b>	IP, TCP, UDP, SMTP, DHCP, RTSP
<b>HDD</b>	<b>Capacity</b>	Up to 16TB

<b>External Interface</b>	<b>Network Interface</b>	1× 10/100 Mbps RJ45 port
	<b>USB Interface</b>	2× USB2.0 interface for mouse and external storage
	<b>Button</b>	1× Reset button
<b>System Requirements</b>	<b>Operating System</b>	Microsoft Windows (Foscam VMS), MacOS (Foscam VMS), Android (Foscam app), iOS (Foscam app)
	<b>Smart Phone</b>	iOS, Android, 3G/4G/5G Smartphones
<b>Language</b>	<b>Language</b>	17 languages
<b>Physical and Environmental</b>	<b>Power Supply</b>	DC 12V/2A
	<b>Dimension(LxWxH)</b>	255mm*238mm*50mm
	<b>Net Weight (g)</b>	780g
	<b>Operating Temperature</b>	0°C ~ 55°C (32°F ~ 131°F)
	<b>Operating Humidity</b>	20% ~ 85% non-condensing
	<b>Storage Temperature</b>	-20°C ~ 60°C (-4°F ~ 140°F)
	<b>Storage Humidity</b>	0% ~ 90% non-condensing

ITEMS		FNA108HE
<b>Video Input</b>	<b>IP Video Input</b>	8 Channels UHD IP camera input
<b>Video Output</b>	<b>HDMI Output</b>	1×HDMI
	<b>VGA Output</b>	1×VGA
	<b>Display Resolution</b>	3840x2160,2560x1440,1920x1080,1440x900,1280x1024,1280x800,1280x720,1024x768
<b>Recording</b>	<b>Recording Resolution</b>	Up to 8MP per channel ( 8ch@8MP )
	<b>Record Mode</b>	Time Scheduled / Motion Detect
	<b>Compression Format</b>	H.264/H.264+
	<b>Synchronous Playback</b>	8 channels synchronous video playback

	<b>Playback Mode</b>	Pause / Stop / Slow / Fast/ Frame Play
<b>Network</b>	<b>POE Standard</b>	IEEE 802.3at/af
	<b>Network Protocol</b>	IP, TCP, UDP, SMTP, DHCP, RTSP
<b>HDD</b>	<b>Capacity</b>	Up to 16TB
<b>External Interface</b>	<b>Network Interface</b>	1× 10/100Mbps RJ45 port
	<b>USB Interface</b>	2× USB2.0 interface for mouse and external storage
	<b>Button</b>	1× Power on/off button,1× Reset button
<b>System Requirements</b>	<b>Operating System</b>	Microsoft Windows (Foscam VMS), MacOS (Foscam VMS), Android (Foscam app),iOS (Foscam app)
	<b>Smart Phone</b>	iOS,Android,3G/4G/5G Smartphones
<b>Language</b>	<b>Language</b>	17 languages
<b>Physical and Environmental</b>	<b>Power Supply</b>	DC 48V/2A
	<b>Dimension(LxWxH)</b>	255mm*238mm*50mm
	<b>Net Weight (g)</b>	880g
	<b>Operating Temperature</b>	0°C ~ 55°C (32°F ~ 131°F)
	<b>Operating Humidity</b>	20% ~ 85% non-condensing
	<b>Storage Temperature</b>	-20°C ~ 60°C (-4°F ~ 140°F)
	<b>Storage Humidity</b>	0% ~ 90% non-condensing

ITEMS		FNA108H
<b>Video Input</b>	<b>IP Video Input</b>	8 Channels UHD IP camera input
<b>Video Output</b>	<b>HDMI Output</b>	1×HDMI
	<b>VGA Output</b>	1×VGA
	<b>Display</b>	3840x2160,2560x1440,1920x1080,1440x900,1280x1024,1280x800,1280x720
	<b>Resolution</b>	20,1024x768
<b>Recording</b>	<b>Recording</b>	Up to 8MP per channel ( 8ch@8MP )

	<b>Resolution</b>	
	<b>Record Mode</b>	Time Scheduled / Motion Detect
	<b>Compression Format</b>	H.264/H.264+
<b>Playback</b>	<b>Synchronous Playback</b>	8 channels synchronous video playback
	<b>Playback Mode</b>	Pause / Stop / Slow / Fast/ Frame Play
<b>Network</b>	<b>Network Protocol</b>	IP, TCP, UDP, SMTP, DHCP, RTSP
<b>HDD</b>	<b>Capacity</b>	Up to 16TB
<b>External Interface</b>	<b>Network Interface</b>	1× 10/100/1000 Mbps RJ45 port
	<b>USB Interface</b>	2× USB2.0 interface for mouse and external storage
	<b>Button</b>	1× Reset button
<b>System Requirements</b>	<b>Operating System</b>	Microsoft Windows (Foscam VMS), MacOS (Foscam VMS), Android (Foscam app), iOS (Foscam app)
	<b>Smart Phone</b>	iOS, Android, 3G/4G/5G Smartphones
	<b>Language</b>	17 languages
<b>Physical and Environmental</b>	<b>Power Supply</b>	DC 12V/2A
	<b>Dimension(LxWxH)</b>	255mm*238mm*50mm
	<b>Net Weight (g)</b>	780g
	<b>Operating Temperature</b>	0°C ~ 55°C (32°F ~ 131°F)
	<b>Operating Humidity</b>	20% ~ 85% non-condensing
	<b>Storage</b>	-20°C ~ 60°C (-4°F ~ 140°F)

	<b>Temperature</b>	
	<b>Storage Humidity</b>	0% ~ 90% non-condensing

ITEMS		FN9108E (FN9108E-B4)
<b>Video Input</b>	<b>IP Video Input</b>	8 Channels QHD IP camera input
<b>Video Output</b>	<b>HDMI Output</b>	1×HDMI
	<b>VGA Output</b>	1×VGA
	<b>Display Resolution</b>	3840x2160,2560x1440,1920x1080,1440x900,1280x1024,1280x800,1280x720,1024x768
<b>Recording</b>	<b>Recording Resolution</b>	Up to 5MP per channel ( 8ch@5MP )
	<b>Record Mode</b>	Time Scheduled / Motion Detect
	<b>Compression Format</b>	H.264/H.264+
<b>Playback</b>	<b>Synchronous Playback</b>	8 channels synchronous video playback
	<b>Playback Mode</b>	Pause / Stop / Slow / Fast/ Frame Play
<b>HDD</b>	<b>Capacity</b>	Up to 16TB
<b>Network</b>	<b>POE Standard</b>	IEEE 802.3at/af
	<b>Network Protocol</b>	IP, TCP, UDP, SMTP, DHCP, RTSP
<b>External Interface</b>	<b>Network Interface</b>	1× 10/100 Mbps RJ45 port

	<b>USB Interface</b>	2× USB2.0 interface for mouse and external storage
	<b>Button</b>	1× Power on/off button, 1× Reset button
<b>Language</b>	<b>Language</b>	17 languages
<b>Physical and Environmental</b>	<b>Power Supply</b>	DC 48V/2A
	<b>Dimension(LxWxH)</b>	255mm*238mm*50mm
	<b>Net Weight (g)</b>	880g
	<b>Operating Temperature</b>	0°C ~ 55°C (32°F ~ 131°F)
	<b>Operating Humidity</b>	20% ~ 85% non-condensing
	<b>Storage Temperature</b>	20°C ~ 60°C (-4°F ~ 140°F)
	<b>Storage Humidity</b>	0% ~ 90% non-condensing

<b>ITEMS</b>		<b>V5EP (FN9108E-B4)</b>
<b>Image Sensor</b>	<b>Sensor Type</b>	High Definition Color CMOS Sensor
	<b>Display Resolution</b>	5.0Megapixels(3072*1728)
	<b>Min. Illumination</b>	0 Lux (With IR Illuminator)
	<b>Lens Type</b>	f:4mm;F2.1
<b>Lens</b>	<b>Night Vision</b>	20m
	<b>Night mode</b>	Manual and automatic modes, when the white light is on, the night vision image is colored



	<b>Angle of view</b>	Diagonal: 94°, Horizontal: 78°, Vertical: 43.6°
<b>Audio</b>	<b>Input/Output</b>	Built-in mic and speaker
	<b>Audio Compression</b>	PCM/AAC
	<b>Siren</b>	Support maximum 100dB alarm siren
<b>Connectivity</b>	<b>IEEE 802.3at/af</b>	√
	<b>Ethernet</b>	RJ45
<b>Software Features</b>	<b>Video Format</b>	H.264/H.264+
	<b>Multi-Stream</b>	Dual streams
	<b>Motion Detection</b>	√
	<b>Human Detection</b>	√
	<b>Vehicle Detection</b>	√
	<b>Day/Night</b>	√
	<b>WDR</b>	√
	<b>Zoom</b>	6X digital zoom function
<b>System Requirements</b>	<b>Operating System</b>	Microsoft Windows (Foscam VMS), MacOS (Foscam VMS), Android (Foscam app), iOS (Foscam app)
	<b>Smart Phone</b>	iOS, Android, 3G/4G/5G Smartphones
	<b>Physical and</b>	
	<b>Waterproof</b>	IP66
	<b>Net Weight</b>	342g

<b>Environmental</b>	<b>Power</b>	Powered by PoE NVR
	<b>Power Consumption</b>	5 Watts (Max.)
	<b>Dimension(LxWxH)</b>	170(L)x66 (W)x66 (H)
	<b>Certification</b>	FCC, CE, RoHS, IP66
	<b>Operating Temperature</b>	-20°C ~ 50°C (-4°F ~ 122°F)
	<b>Operating Humidity</b>	10% ~ 80% non-condensing
	<b>Storage Temperature</b>	-20°C ~ 60°C (-4°F ~ 140°F)
	<b>Storage Humidity</b>	0% ~ 90% non-condensing

<b>ITEMS</b>		<b>FN9108E (FN9108E-T4)</b>
<b>Video Input</b>	<b>IP Video Input</b>	8 Channels QHD IP camera input
<b>Video Output</b>	<b>HDMI Output</b>	1×HDMI
	<b>VGA Output</b>	1×VGA
	<b>Display Resolution</b>	3840x2160,2560x1440,1920x1080,1440x900,1280x1024,1280x800,1280x720,1024x768
	<b>Recording Resolution</b>	Up to 5MP per channel ( 8ch@5MP )
<b>Recording</b>	<b>Record Mode</b>	Time Scheduled / Motion Detect
	<b>Compression</b>	H.264/H.264+

	<b>Format</b>	
<b>Playback</b>	<b>Synchronous Playback</b>	8 channels synchronous video playback
	<b>Playback Mode</b>	Pause / Stop / Slow / Fast/ Frame Play
<b>HDD</b>	<b>Capacity</b>	Up to 16TB
<b>Network</b>	<b>POE Standard</b>	IEEE 802.3at/af
	<b>Network Protocol</b>	IP, TCP, UDP, SMTP, DHCP, RTSP
<b>External Interface</b>	<b>Network Interface</b>	1× 10/100 Mbps RJ45 port
	<b>USB Interface</b>	2× USB2.0 interface for mouse and external storage
	<b>Button</b>	1× Power on/off button, 1× Reset button
<b>Language</b>	<b>Language</b>	17 languages
<b>Physical and Environmental</b>	<b>Power Supply</b>	DC 48V/2A
	<b>Dimension(LxWxH)</b>	255mm*238mm*50mm
	<b>Net Weight (g)</b>	880g
	<b>Operating Temperature</b>	0°C ~ 55°C (32°F ~ 131°F)
	<b>Operating Humidity</b>	20% ~ 85% non-condensing
	<b>Storage Temperature</b>	-20°C ~ 60°C (-4°F ~ 140°F)
	<b>Storage Humidity</b>	0% ~ 90% non-condensing

ITEMS		T5EP(FN9108E-T4)
Image Sensor	Sensor Type	High Definition Color CMOS Sensor
	Display Resolution	5.0Megapixels(3072*1728)
	Min. Illumination	0 Lux (With IR Illuminator)
Lens	Lens Type	f:4mm;F2.1
	Night Vision	20m
	Night mode	Manual and automatic modes,when the white light is on, the night vision image is colored
	Angle of view	Diagonal: 94° , Horizontal: 78° , Vertical: 43.6°
Audio	Input/Output	Built-in mic and speaker
	Audio Compression	PCM/AAC
	Siren	Support maximum 100dB alarm siren
Connectivity	IEEE 802.3at/af	√
	Ethernet	RJ45
Software Features	Video Format	H.264/H.264+
	Multi-Stream	Dual streams
	Motion Detection	√
	Human Detection	√

	<b>Vehicle Detection</b>	✓
	<b>Day/Night</b>	✓
	<b>WDR</b>	✓
	<b>Zoom</b>	6X digital zoom function
	<b>Spotlight</b>	✓
<b>System Requirements</b>	<b>Operating System</b>	Microsoft Windows (Foscam VMS), MacOS (Foscam VMS), Android (Foscam app), iOS (Foscam app)
	<b>Smart Phone</b>	iOS, Android, 3G/4G/5G Smartphones
<b>Physical and Environmental</b>	<b>Waterproof</b>	IP66
	<b>Net Weight</b>	380g
	<b>Power</b>	Powered by PoE NVR
	<b>Power Consumption</b>	5 Watts (Max.)
	<b>Dimension</b>	φ110*100 mm
	<b>Certification</b>	FCC, CE, RoHS, IP66
	<b>Operating Temperature</b>	-20°C ~ 50°C (-4°F ~ 122°F)
	<b>Operating Humidity</b>	10% ~ 80% non-condensing
	<b>Storage Temperature</b>	-20°C ~ 60°C (-4°F ~ 140°F)
	<b>Storage Humidity</b>	0% ~ 90% non-condensing

ITEMS		FNA108E (FNA108E-B4)
<b>Video Input</b>	<b>IP Video Input</b>	8 Channels UHD IP camera input
<b>Video Output</b>	<b>HDMI Output</b>	1×HDMI
	<b>VGA Output</b>	1×VGA
	<b>Display Resolution</b>	3840x2160,2560x1440,1920x1080,1440x900,1280x1024,1280x800,1280x720,1024x768
<b>Recording</b>	<b>Recording Resolution</b>	Up to 8MP per channel ( 8ch@8MP )
	<b>Record Mode</b>	Time Scheduled / Motion Detect
	<b>Compression Format</b>	H.264/H.264+
<b>Playback</b>	<b>Synchronous Playback</b>	8 channels synchronous video playback
	<b>Playback Mode</b>	Pause / Stop / Slow / Fast/ Frame Play
<b>HDD</b>	<b>Capacity</b>	Up to 16TB
<b>Network</b>	<b>POE Standard</b>	IEEE 802.3at/af
	<b>Network Protocol</b>	IP, TCP, UDP, SMTP, DHCP, RTSP
<b>External Interface</b>	<b>Network Interface</b>	1× 10//100 Mbps RJ45 port
	<b>USB Interface</b>	2× USB2.0 interface for mouse and external storage
	<b>Button</b>	1× Power on/off button,1× Reset button
<b>Language</b>	<b>Language</b>	17 languages
<b>Physical</b>	<b>Power Supply</b>	DC 48V/2A

<b>and Environmen tal</b>	<b>Dimension(LxW xH)</b>	255mm*238mm*50mm
	<b>Net Weight (g)</b>	880g
	<b>Operating Temperature</b>	0°C ~ 55°C (32°F ~ 131°F)
	<b>Operating Humidity</b>	20% ~ 85% non-condensing
	<b>Storage Temperature</b>	-20°C ~ 60°C (-4°F ~ 140°F)
	<b>Storage Humidity</b>	0% ~ 90% non-condensing

<b>ITEMS</b>		<b>V8EP(FNA108E-B4)</b>
<b>Image Sensor</b>	<b>Sensor Type</b>	High Definition Color CMOS Sensor
	<b>Display Resolution</b>	8.0Megapixels(3840*2160)
	<b>Min. Illumination</b>	0 Lux (With IR Illuminator)
<b>Lens</b>	<b>Lens Type</b>	f:4.3mm; F1.6
	<b>Night Vision</b>	20m
	<b>Night mode</b>	Manual and automatic modes,when the white light is on, the night vision image is colored
	<b>Angle of view</b>	Diagonal: 108.5°, Horizontal: 90.1°, Vertical 46.2°
<b>Audio</b>	<b>Input/Output</b>	Built-in mic and speaker
	<b>Audio Compression</b>	PCM/AAC

	<b>Siren</b>	Support maximum 100dB alarm siren
<b>Connectivity</b>	<b>IEEE 802.3at/af</b>	√
	<b>Ethernet</b>	RJ45
<b>Software Features</b>	<b>Video Format</b>	H.264/H.264+
	<b>Multi-Stream</b>	Dual streams
	<b>Motion Detection</b>	√
	<b>Human Detection</b>	√
	<b>Vehicle Detection</b>	√
	<b>Day/Night</b>	√
	<b>HDR</b>	√
	<b>Zoom</b>	6X digital zoom function
	<b>Spotlight</b>	√
<b>System Requirements</b>	<b>Operating System</b>	Microsoft Windows (Foscam VMS), MacOS (Foscam VMS), Android (Foscam app), iOS (Foscam app)
	<b>Smart Phone</b>	iOS, Android, 3G/4G/5G Smartphones
<b>Physical and Environmental</b>	<b>Waterproof</b>	IP66
	<b>Net Weight</b>	342g
	<b>Power</b>	Powered by PoE NVR
	<b>Power Consumption</b>	5 Watts (Max.)



	<b>Dimension(LxWxH)</b>	170(L)x66 (W)x66 (H)
	<b>Certification</b>	FCC, CE, RoHS, IP66
	<b>Operating Temperature</b>	-20°C ~ 40°C (-4°F ~ 104°F)
	<b>Operating Humidity</b>	10% ~ 80% non-condensing
	<b>Storage Temperature</b>	-20°C ~ 60°C (-4°F ~ 140°F)
	<b>Storage Humidity</b>	0% ~ 90% non-condensing

ITEMS		FNA108E (FNA108E-T4)
<b>Video Input</b>	<b>IP Video Input</b>	8 Channels UHD IP camera input
<b>Video Output</b>	<b>HDMI Output</b>	1×HDMI
	<b>VGA Output</b>	1×VGA
	<b>Display Resolution</b>	3840x2160,2560x1440,1920x1080,1440x900,1280x1024,1280x800,1280x720,1024x768
<b>Recording</b>	<b>Recording Resolution</b>	Up to 8MP per channel ( 8ch@8MP )
	<b>Record Mode</b>	Time Scheduled / Motion Detect
	<b>Compression Format</b>	H.264/H.264+
<b>Playback</b>	<b>Synchronous Playback</b>	8 channels synchronous video playback
	<b>Playback Mode</b>	Pause / Stop / Slow / Fast/ Frame Play

<b>HDD</b>	<b>Capacity</b>	Up to 16TB
<b>Network</b>	<b>POE Standard</b>	IEEE 802.3at/af
	<b>Network Protocol</b>	IP, TCP, UDP, SMTP, DHCP, RTSP
<b>External Interface</b>	<b>Network Interface</b>	1× 10/100 Mbps RJ45 port
	<b>USB Interface</b>	2× USB2.0 interface for mouse and external storage
	<b>Button</b>	1× Power on/off button, 1× Reset button
<b>Language</b>	<b>Language</b>	17 languages
<b>Physical and Environmental</b>	<b>Power Supply</b>	DC 48V/2A
	<b>Dimension(LxWxH)</b>	255mm*238mm*50mm
	<b>Net Weight (g)</b>	880g
	<b>Operating Temperature</b>	0°C ~ 55°C (32°F ~ 131°F)
	<b>Operating Humidity</b>	20% ~ 85% non-condensing
	<b>Storage Temperature</b>	-20°C ~ 60°C (-4°F ~ 140°F)
	<b>Storage Humidity</b>	0% ~ 90% non-condensing

<b>ITEMS</b>		<b>T8EP(FNA108E-B4)</b>
<b>Image Sensor</b>	<b>Sensor Type</b>	High Definition Color CMOS Sensor
	<b>Display</b>	8.0Megapixels(3840*2160)

	<b>Resolution</b>	
	<b>Min. Illumination</b>	0 Lux (With IR Illuminator)
<b>Lens</b>	<b>Lens Type</b>	f:4.3mm; F1.6
	<b>Night Vision</b>	20m
	<b>Night mode</b>	Manual and automatic modes,when the white light is on, the night vision image is colored
	<b>Angle of view</b>	Diagonal: 108.5°, Horizontal: 90.1°, Vertical 46.2°
<b>Audio</b>	<b>Input/Output</b>	Built-in mic and speaker
	<b>Audio Compression</b>	PCM/AAC
	<b>Siren</b>	Support maximum 100dB alarm siren
<b>Connectivity</b>	<b>IEEE 802.3at/af</b>	√
	<b>Ethernet</b>	RJ45
<b>Software Features</b>	<b>Video Format</b>	H.264/H.264+
	<b>Multi-Stream</b>	Dual streams
	<b>Motion Detection</b>	√
	<b>Human Detection</b>	√
	<b>Vehicle Detection</b>	√
	<b>Day/Night</b>	√
	<b>HDR</b>	√

	<b>Zoom</b>	6X digital zoom function
	<b>Spotlight</b>	√
<b>System Requirements</b>	<b>Operating System</b>	Microsoft Windows (Foscam VMS), MacOS (Foscam VMS), Android (Foscam app), iOS (Foscam app)
	<b>Smart Phone</b>	iOS, Android, 3G/4G/5G Smartphones
<b>Physical and Environmental</b>	<b>Waterproof</b>	IP66
	<b>Net Weight</b>	380g
	<b>Power</b>	Powered by PoE NVR
	<b>Power Consumption</b>	5 Watts (Max.)
	<b>Dimension</b>	φ110*100 mm
	<b>Certification</b>	FCC, CE, RoHS, IP66
	<b>Operating Temperature</b>	-20°C ~ 40°C (-4°F ~ 104°F)
	<b>Operating Humidity</b>	10% ~ 80% non-condensing
	<b>Storage Temperature</b>	-20°C ~ 60°C (-4°F ~ 140°F)
<b>Storage Humidity</b>	0% ~ 90% non-condensing	

## 5.3 FAQ

### 1. No image displayed on the monitor after starting up normally.

- Verify the device is connected with the monitor via HD-OUT or VGA cable.
- Verify the connection cable is good.
- Verify Input mode of the monitor is correct.

Please check the input mode of the monitor matches with the output mode of the device (e.g. if the output mode of NVR is HD-OUT output, then the input mode of monitor must be the HD-OUT input).

And if not, please modify the input mode of monitor.

### 2. No record file found in the NVR local HDD, and prompt "No record file found".

- Verify the system time setting is correct.

Choose **Menu > Settings > General** in the GUI interface, and verify the time is correct.

- Verify the search condition is correct.

Choose **Menu > Playback** in the GUI interface, and verify the channel and time are correct.

- Verify the HDD status is normal.

Choose **Menu > About > HDD Info** in the GUI interface, view the HDD status.

### 3. Why recording is not performed after motion detection is enabled?

On the "Motion Detection" page, check whether the following are correctly set:

- Check whether the motion detection channel is correct.
- Check whether a trigger time segment is set.
- Check whether a detection area is set.
- Check whether recording is selected.

### 4. The screen of the display is incomplete.

Confirm the current resolution and check the resolution supported by the display. If the resolution is 1920\*1080, the display needs to support the resolution 1920\*1080.

### 5. Why can't video files be downloaded during video playback or downloaded files cannot be played back properly?

To save consumed resources, the server limits concurrency of video playback and file download. In this case, stop video playback and then download files or play back videos after video files are downloaded.

## 5.4 Glossary

Acronym	Term	Description
DDNS	Dynamic Domain Name Server	Dynamic DNS is a method, protocol, or network service that provides the capability for a networked device, such as a router or computer system using the Internet Protocol Suite, to notify a domain name server to change, in real time (ad-hoc) the active DNS configuration of its configured hostnames, addresses or other information stored in DNS.
DHCP	Dynamic Host Configuration Protocol	DHCP is a network application protocol used by devices (DHCP clients) to obtain configuration information for operation in an Internet Protocol network.
HDD	Hard Disk Drive	A storage medium which stores digitally encoded data on platters with magnetic surfaces.
PPPoE	Point-to-Point Protocol over Ethernet	It is a network protocol for encapsulating Point-to-Point Protocol (PPP) frames inside Ethernet frames. It is used mainly with ADSL services where individual users connect to the ADSL transceiver (modem) over Ethernet and in plain Metro Ethernet networks.
PTZ	Pan, Tilt, Zoom	PTZ cameras are motor driven systems that allow the camera to pan left and right, tilt up and down and zoom in and out.
NTP	Network Time Protocol	A protocol designed to synchronize the clocks of computers over a network.
NVR	Network Video Recorder	A NVR can be a PC-based or embedded system used for centralized management and storage for IP cameras.
VMS	Video Management System	Foscam VMS is a new tool for PC. It does not require plug-ins and is compatible with Windows & Mac, It supports all Foscam HD cameras and up to 36 cameras at the same time.

## 5.5 CE & FCC

### Electromagnetic Compatibility (EMC)

#### FCC Statement



**This device complies with FCC Rules Part 15. Operation is subject to the following two conditions.**

- This device may not cause harmful interference.
- This device must accept any interference received, including interference that may cause undesired operation.

This equipment has been tested and found to comply with the limits for a Class A digital device, pursuant to Part 15 of the FCC Rules. These limits are designed to provide reasonable protection against harmful interference when the equipment is operated in a commercial environment. This equipment generates, uses, and can radiate radio frequency energy and, if not installed and used in accordance with the installation manual, may cause harmful interference to radio communications. Operation of this equipment in a residential area is like to cause harmful interference, in which case the user will be required to correct the interference at his own expense.

#### FCC Caution

Any changes or modification not expressly approved by the party responsible for compliance could void the user's authority to operate this equipment.

#### CE Mark Warning



This is a Class A product. In a domestic environment, this product may cause radio interference, in which case the user may be required to take adequate measures.

## 5.6 WARRANTY

FOSCAM values your business and always attempts to provide you the very best of service.

No limited hardware warranty is provided by FOSCAM unless your **Foscam** product ("product") was purchased from an authorized distributor or authorized reseller. Distributors may sell products to resellers who then sell products to end users. No warranty service is provided unless the product is

returned to an authorized return center in the region where the product was first shipped by FOSCAM or to the point-of-purchase, which may have regional specific warranty implications.

**If you purchase your Foscam product from online store, please contact the point-of-purchase and ask for return / replacement / repair service.**

## **Limited Hardware Warranty**

- The products are warranted to be free from manufacturing defects in materials and workmanship starting from the shipping date of **Foscam**.

This limited hardware warranty does not cover:

- Software, including the software added to the products through our factory-integration system, software, etc.
- Usage that is not in accordance with product instructions.
- Failure to follow the product instructions.
- **Normal wear and tear.**

## **Return Procedures**

- Please read **Foscam** warranty policy & policy of your reseller first before sending items back to point-of-purchase.
- Customer must first contact point-of-purchase to obtain a Return Merchandise Authorization (RMA) number before returning the product. If the product you received is suspected to be defective and the product warranty has not expired, The RMA number will allow your reseller to track your return much easier and help them expedite processing your request.
- After receiving your RMA case number, pack the item(s) very well with the original box and all the original accessories included such as power adapters, brackets, cables, manuals.
- Write your RMA number and the return reason (the problem of the product) on the warranty card along with the complete package to send them back.

## **Replacement Services**

- **If customers ask for replacement service, please contact point-of-purchase and follow their policy.**
- Our technicians will inspect all items returned for replacement requests. If the returned product is found in working order, we will return the same item received. However customers shall be responsible for all shipping & handling charges incurred for getting the units back to customers.
- If returned products are found defective, we will replace the product and assume the shipping cost



for sending back the replacement unit to customers.

- If for any reason, we are unable to provide a replacement of the original returned item(s). You will have a choice for a "Substitute" item at the same equal value.
- We do not provide exchange and replacement due to normal hardware upgrade according the market after 14 days after the product is delivered.
- Our technicians will test the product before send out the replacement, any other demand for more than two times replacement for the same product during replacement limit will be rejected.
- **Replaced products are warranted from the balance of the former warranty period.**

## **Warranty Forfeiture**

- Warranty is void if purchase from unauthorized distributor or reseller.
- Warranty is void if trade-mark, serial tags, product stickers have been removed, altered or tampered with.
- Warranty is void for mishandling, improper use, or defacing the product.
- Warranty is void for physical damage, altered, either internally or externally, improper or inadequate packaging when returned for RMA purposes.
- Warranty is void if damage has resulted from accident, dismantle, abuse, or service or modification by someone other than the appointed vendor, source, fission or the spare part has been over the period of warranty.
- Warranty is void if product is damaged due to improper working environment or operation. (For example, improper temperature, humidity, unusual physical or electrical stress or interference, failure or fluctuation of electrical power, static electricity, using wrong power adapter, etc.)
- Warranty is void if damaged by the use of parts not manufactured or sold by FOSCAM.
- Damage caused by improper installation of third-party products.
- Warranty is void if damaged for irresistible cause, such as earthquake, fire, lightning, flood, etc.
- Product beyond limited warranty.

## **Shipping Fee**

- If products are defective or damaged under normal use or operation in the replacement limit, distributors or resellers are responsible for the shipping cost the product back to customers, customers should assume the shipping cost send the product to the point-of-purchase.
- During replacement limit, if customers ask for replacement due to the product does not fit for customer's personal expectation, customers should responsible for both shipping fee.
- Customers shall be responsible for both shipping fee if their product beyond the replacement limit but still in warranty limit.

## **Repair Service Out Of Warranty**

- FOSCAM provide extra repair service for product that out of warranty, it is chargeable. The total fee contains device cost and service fee. Device cost (including accessories) is the standard uniform price provide by FOSCAM.
- Different region may have different service fee, please contact the point-of-purchase to confirm that before you ask for this service.
- Our technicians will quote the total price after detect the product, If customers refused to repair after the quotation, customers need pay for the test fee, \$3.5/hour. If agree with the quotation, test will be free.
- Repaired product out of warranty will obtains 3-month warranty from the date of the product back to customers.

## **Limitation of Liability**

- **Foscam** is not responsible for other extra warranty or commitment promised by resellers, if your reseller promised some extra commitment or warranty; please ask for written documents to protect your rights and interests.
- **Foscam** does not offer refunds under any circumstances. Please contact the point-of-purchase and follow their refund / return policy.
- **Foscam** shall not be liable under any circumstances for any consequential, incidental, special or exemplary damages arising out of or in any connection with this agreement or the products, including but not limited to lost profits, or any claim based on indemnity or contribution, or the failure of any limited or exclusive remedy to achieve its essential purpose or otherwise. Purchaser's exclusive remedy, as against **Foscam**, shall be the repair or replacement of defective parts. If **Foscam** lists a product on its website specification in error or that is no longer available for any reason, **Foscam** reserves the right to explain it without incurring any liability.

**All rights reserved. FOSCAM and the Foscam logo are trademarks of ShenZhen FOSCAM Intelligent Technology Limited., registered in the U.S. and other countries.**

## 5.7 Statement

You are advised to be cautious in daily life, keep personal account information carefully, do not share personal account easily. Change passwords of your account and equipment periodically, and upgrade equipment firmware to strengthen security consciousness.

Our company makes no warranty, implied or otherwise, that this product is suitable for any particular purpose or use. You need to abide by the relevant laws and regulations of the use restrictions when using products. Our company takes no responsibility of illegal activities by using our products.

Our company takes no responsibility of the loss by force majeure, such as failure or faults of telecom system or the Internet network, computer viruses, malicious attacks of hackers, information damage or loss, and faults of computer system.

My company does not need to take any responsibility of the special, incidental or corresponding loss by the products of our company or any software provide by our company, including but not limited to operating loss, profit or purpose. The company only takes the responsibility applicable to national and local legal requirements.

Our company takes no responsibility of the loss caused by the following at ant time:

- 1) loss of purchases;
- 2) loss of intangible property damage, such as data, programs;
- 3) loss of compensation claimed by third-party customers.

Delete images, format the memory card or other data storage devices does not completely remove the original image data. You can restore deleted files from discarded the storage device by commercial software, but which will potentially lead to personal image data used maliciously by others. The privacy of the data security belongs to user responsibility, the company takes no responsibility.

Parts mentioned in this statement should not be understood by the configuration description of the product purchased by the customer, the product configuration must accord to the specific models purchased by the customer.

Without the prior written permission of my company, all the contents of relevant operating instructions manual affiliated to the product must not be reproduced, transmitted, transcribed or stored in a retrieval system, or translated into other languages.

Our company will reserve the right to improve and modify the product and corresponding manuals.

The company reserves the right of final interpretation on our products.

## 5.8 Obtaining Technical Support

While we hope your experience with the NVR is enjoyable and easy to use, you may experience some issues or have questions that this User's Guide has not answered.

If you have problem with device, please first contact reseller for solving the problems.

If our reseller cannot provide service, please contact our service department:

[support@foscam.com](mailto:support@foscam.com)



CE Certificate statement Website:

<https://www.foscam.com/company/ce-certificate.html>

Exporter and Importer Information Opened to Public:

<https://www.foscam.com/company/open-information.html>

[www.foscam.com](http://www.foscam.com)

Manufacturer: Shenzhen Foscam Intelligent Technology Co., Ltd

Addr: : Room 902,Building 1B, Shenzhen International Innovation Valley, Xingke 1st Street, Nanshan District, Shenzhen, Guangdong, China, 518055